

CONTENTS

TOOLS	3
EQUIPMENT	33
DIAMOND CUTTING AND DRILLING	75
OXIDES	89
CONCRETE CONSUMABLES	91
LADDERS & PLATFORMS	107
SCAFFOLDING	125
EDGE PROTECTION	135
HEIGHT SAFETY	141
ELEVATED WORK PLATFORMS	151
LIGHTING SOLUTIONS	155
PROPPING	159
FENCING	169

**Supplying all the
tools & equipment
you need for
concrete placing
and finishing!**





TOOLS

TOOLS





Trowels



Finishing Trowels

Marshalltown Carbon Steel Round Front

Code	Size
MXS66RED	400mm x 100mm Durasoft handle
MXS81RED	450mm x 100mm Durasoft handle
MXS20RED	500mm x 100mm Durasoft handle
MXS205RD	500mm x 125mm Durasoft handle

Marshalltown Carbon Steel Round Both Ends

Code	Size
MXS64FRD	350mm x 100mm Durasoft handle
MXS66FRD	400mm x 100mm Durasoft handle
MXS81FRD	450mm x 100mm Durasoft handle
MXS20FRD	500mm x 100mm Durasoft handle
MXS205FD	500mm x 125mm Durasoft handle



Master Finish Carbon Steel Round Front

Code	Size
MF122SS	450mm x 100mm plastic handle



Master Finish Carbon Steel Round Both Ends

Code	Size
MF121A	350mm x 100mm plastic handle
MF122S	450mm x 100mm plastic handle
MF126S	555mm x 120mm plastic handle

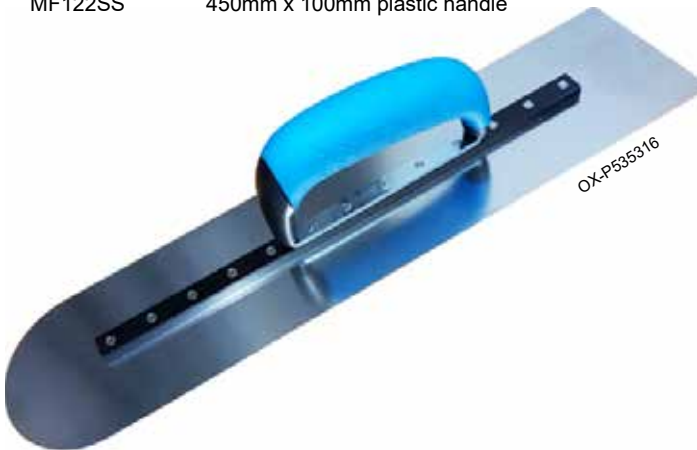

Ox Aluminium Steel Round Front

Code	Size
OX-P535316	400mm x 120mm duragrip handle
OX-P535318	450mm x 120mm duragrip handle



Marshalltown Carbon Steel Square Ends

Code	Size
MTMXS1D	280mm x 115mm Durasoft handle
MXS64D	350mm x 100mm Durasoft handle
MXS66D	400mm x 100mm Durasoft handle
MXS81D	450mm x 100mm Durasoft handle
MXS20D	500mm x 100mm Durasoft handle
MXS205D	500mm x 125mm Durasoft handle



Master Finish Carbon Steel Square Ends

Code	Size
MF102A	280mm x 120mm plastic handle
MF181A	405mm x 115mm plastic handle



Ox Pro Square Finishing Trowels

Code	Size
OX-P014702	120mm x 280mm Duragrip handle
OX-P014773	120mm x 356mm Duragrip handle
OX-P014781	120mm x 405mm Duragrip handle

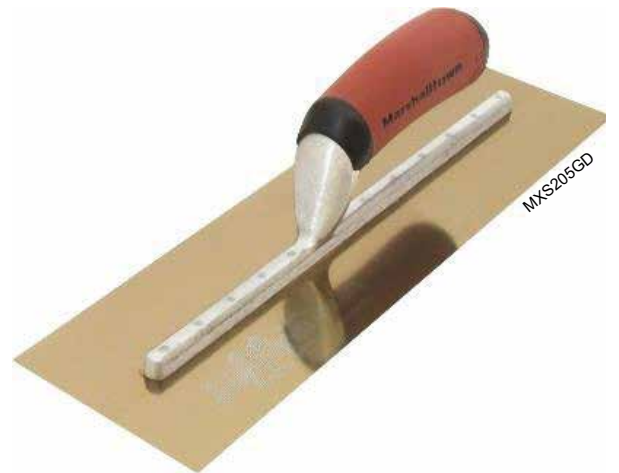

Marshalltown Stainless Steel Square Ends

Code	Size
MXS1GSD	280mm x 115mm Durasoft handle
MXS62GSD	300mm x 100mm Durasoft handle
MXS64GSD	350mm x 100mm Durasoft handle
MXS66GSD	400mm x 100mm Durasoft handle
MXS7GSD	300mm x 125mm Durasoft handle
MXS145GD	350mm x 125mm Durasoft handle
MXS165GD	400mm x 125mm Durasoft handle
MXS815GD	450mm x 125mm Durasoft handle
MXS205GD	500mm x 125mm Durasoft handle



Ox Pro Gold Steel Trowels

Code	Size
OX-P407311	114mm x 280mm Duragrip handle
OX-P407314	127mm x 356mm Duragrip handle



Pool Trowels

Marshalltown Carbon Steel Round Ends

Code	Size
MTSP10SD	250mm x 75mm with short shank Durasoft handle
MTSP12SD	300mm x 90mm with short shank Durasoft handle
MTSP14SD	350mm x 100mm with short shank Durasoft handle
MTSP16SD	400mm x 113mm with short shank Durasoft handle
MTSP815SD	450mm x 125mm with short shank Durasoft handle
MTSP205SD	500mm x 125mm with short shank Durasoft handle



Marshalltown Stainless Steel Round Ends

Code	Size
MTSP14GSD	350mm x 100mm Durasoft handle
MTSP16GSD	400mm x 113mm Durasoft handle



Master Finish Carbon Steel Round Ends

Code	Size
MF121A	350mm x 100mm with plastic handle
MF122A	450mm x 100mm with plastic handle
MF126A	555mm x 120mm with plastic handle



Magnesium Trowels

Marshalltown Square Ends

Brand	Code	Size
Marshalltown	MT142D	300mm x 80mm Durasoft handle
Marshalltown	MT145D	400mm x 80mm Durasoft handle
Marshalltown	MT146D	500mm x 80mm Durasoft handle
Marshalltown	MT143D	400mm x 80mm round ends with Durasoft handle



Kea Magnesium Square Ends

Brand	Code	Size
Kea	TSSMAG3	300mm
Kea	TSSMAG4	400mm
Kea	TSSMAG5	500mm



Pointed Trowels

Carbon Steel

Brand	Code	Size
Ox	OX-T017309	100mm x 355mm with plastic handle
Ox	OX-T017391	115mm x 405mm with plastic handle
Ox	OX-T017392	115mm x 450mm with plastic handle



Coving Trowels

Dish Drain



Brand	Code	Size
Master Finish	MF206	50mm



MT834D

Groovers

150mm x 1110mm Groovers

Brand	Code	Size
Marshalltown	MT834D	10mm x 19mm groove
Marshalltown	MT835D	10mm x 25mm groove
Marshalltown	MT180	13mm x 13mm groove



MT180



120mm

Brand	Code	Size
Master Finish	MF466	75mm



MT68SSD

Stainless Steel Outside Corner Trowel

Brand	Code	Size
Marshalltown	MT68SSD	13mm radius 150mm x 63mm



Edgers

Ox 20mm Radius

Code	Size
OX-P014820	130 x 190mm x 20mm



Marshalltown

Code	Size
MT136	150 x 75 x 10mm
MT156SSD	150 x 100 x 10mm



Marshalltown 10mm Radius

Code	Size
MT130SSD	150 x 250mm x 10mm Big I



Code	Size
MT4268	150 x 113 x 19mm outside curb tool



Ox 25mm Radius

Code	Size
OX-P014925	145 x 215mm x 25mm
OX-P014825	130 x 190mm x 25mm



Code	Size
MT92	150 x 70 x 10mm wooden handle



Master Finish

Code	Size
MF413	120 x 45 degree bevelled edge





TW6280

Floats

Stanway Plastic Floats

Code	Size
TW6280	280 x 110mm medium dense plastic float
TW6340	340 x 150mm medium dense plastic float



Windlock PVC Float

Code	Size
T-PFWHITECS	140 x 280mm PVC float



Ox PU Floats

Code	Size
OX-P010220	200 x 360mm PU float
OX-P010222	220 x 420mm PU float



Ox Steel Floats

Code	Size
OX-P013938	150 x 380mm stainless steel



Ox Steel Floats - Reversible Duragrip Handle

Code	Size
OX-P013910	100 x 290mm stainless steel
OX-P013916	160 x 210mm stainless steel



Brick Trowels

Philadelphia Pattern

Brand	Code	Size
Marshalltown	MT19-FG11	275mm x 138mm
Marshalltown	MT19-FG12	300mm x 150mm



London Pattern

Brand	Code	Size
Marshalltown	MT33-FG10	250mm x 120mm
Marshalltown	MT33-FG11	275mm x 122mm



Bucket Trowel - Wooden Handle

Brand	Code	Size
Marshalltown	MT19-8.25	206mm x 138mm



Pointing Trowels

Brand	Code	Size
Marshalltown	MT95	140mm
Marshalltown	MT925	175mm



Window Trowels

Trowel & Square

Brand	Code	Size
Ox	OX-P010113	13mm
Ox	OX-P010116	16mm
Ox	OX-P010119	19mm
Ox	OX-P010125	25mm



Tuck Pointer with Wooden Handle

Brand	Code	Size
Marshalltown	MT503-06	6mm
Marshalltown	MT504-08	8mm
Marshalltown	MT505-10	10mm
Marshalltown	MT506-13	13mm
Marshalltown	MT507-16	16mm



Margin Trowel

Tempered Blade with Hardwood Handle

Brand	Code	Size
Marshalltown	MT97	125mm x 50mm



Gauging Trowels

Tempered Blade with Hardwood Handle

Brand	Code	Size
Ox	OX-P011407	175mm
Ox	OX-P011408	200mm



Concrete Screeds

Heavy Duty Structural Alloy with Level

Brand	Code	Size
Ox	OX-P021312	1200mm
Ox	OX-P021315	1500mm
Ox	OX-P021318	1800mm
Ox	OX-P021321	2100mm
Ox	OX-P021324	2400mm
Ox	OX-P021327	2700mm
Ox	OX-P021330	3000mm
Ox	OX-P021336	3600mm



Kea Concrete Screed

Brand	Code	Size
Kea	COCO2860	4800mm



Clamp on Style Handle with Level

Brand	Code	Size
Master Finish	MFC12L	1200mm
Master Finish	MFC18L	1800mm
Master Finish	MFC24L	2400mm
Master Finish	MFC30L	3000mm
Master Finish	MFC36L	3600mm

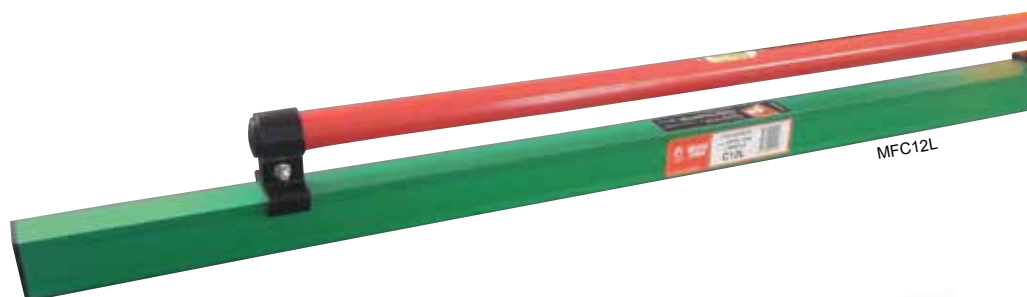

Bull Floats



Master Finish Alloy Bull Floats

Code	Size
MF1063	900mm
MF1064	1200mm
MF1065	1500mm
MF1068	1800mm



Ox Alloy Bull Floats

Code	Size
P016606	600 x 150mm
P016609	900 x 150mm
P016612	1200 x 150mm
P016615	1500 x 150mm
P016618	1800 x 150mm



KTCC735

Kraft Magnesium Bull Float Square Ends

Code	Size
KTCC735-01	900mm
KTCC802-01	1200mm
KTCC760-01	1500mm
KTCC761-01	1800mm

(Tilt bracket not included)



KTCC750-01

Kraft Carbon Blue Steel Bull Floats - Round Ends

Carbon blue steel blade with rounded ends for producing super smooth finish. Heavy-duty 4" C-Channel design for extra rigidity and flatness.

Code	Size
KTCC750-01	1200mm
KTCC749-01	1500mm
KTCC751-01	1800mm

(Tilt bracket not included)



TSS Magnesium Bull Float Square Ends

Code	Size
TSSBFS915	915mm
TSSBFS1220	1220mm

(Tilt bracket & handle not included)



Kea Carbon Blue Steel Bull Floats - Round Ends

Code	Size
TSSBIGD915	915mm
TSSBIGD1220	1220mm
TSSBIGD1500	1500mm
TSSBIGD1800	1800mm

(Tilt bracket & handle not included)



KTCC736

Kraft Magnesium Bull Floats - Round Ends

Code	Size
KTCC736-01	900mm
KTCC803-01	1200mm
KTCC804-01	1500mm
KTCC808-01	1800mm

(Tilt bracket not included)

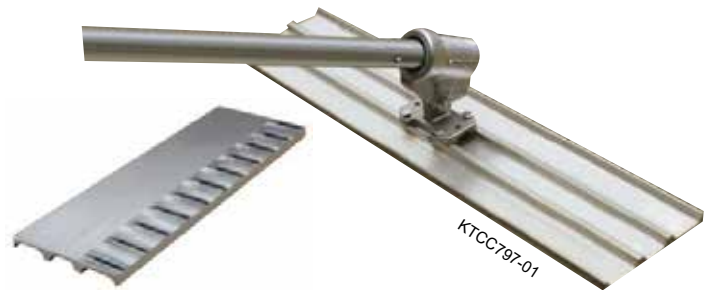

Kraft Grooved Bull Float

Grooves on 1 inch centres. Produces a uniform sharp groove in various concrete applications.

Code	Size
KTCC797-01	900mm
KTCC796-01	1200mm

(Tilt bracket not included)



Kea Magnesium Bull Float Round Ends

Code	Size
TSSBFR915	915mm
TSSBFR1220	1220mm

(Tilt bracket & handle not included)



Channel Float

1800mm Magnesium Channel Float, special design improves flatness. Ideal for many jobs such as flat work, paving etc.

Code	Size
TSSCHANNEL	1800mm

Bull Float Handle Fittings

Brand	Code	Size
Kea	TSSDBSPRING	Spring steel double button clip 1-3/4" diameter
Master Finish	MF45-30	Button spring clip for clip handle
Ox	OX-P019501	Telescopic handle part
		Plastic collet/end cap
Master Finish	MF1066FP	Plastic collet fitting to suit telescopic handle



Adaptors

Brand	Code	Size
Ox	OX-P019102	Extrusion facilities handle adaptor for clip together handles to standard bullfloats
Ox	OX-P409901	Adaptor end piece for telescopic poles to standard bullfloat
Ox	OX-P019710	Quick release pin



Brackets

Brand	Code	Description
Kea	TSSBRACKET	Uses 1-3/4" or 1-3/8 Aluminium button type handles
Kea	TSSCHAINBRACKET	Uses 1-3/4" or 1-3/8 Aluminium button type handles
Kraft	CC296	Knucklehead® II Tilt Float Bracket - 6 Hole
Kraft	CC294	EZY-Tilt® II Float Bracket 6 Hole



Fresno Trowels

Walking Trowels



Round Ends Tilt Bracket

High grade stainless steel. Complete with tilt bracket and round ends.

Brand	Code	Size
Ox	OX-P402960	120 x 600mm
Ox	OX-P402990	120 x 900mm

Round Ends

High grade stainless steel. Complete with fixed bracket and round ends

Brand	Code	Size
Ox	OX-P402760	600mm
Ox	OX-P402790	900mm





Concrete Tool Handles & Accessories



Concrete Tool Handles

Brand	Code	Size
Master Finish	MF1076	Telescopic handle 2.7 - 5m

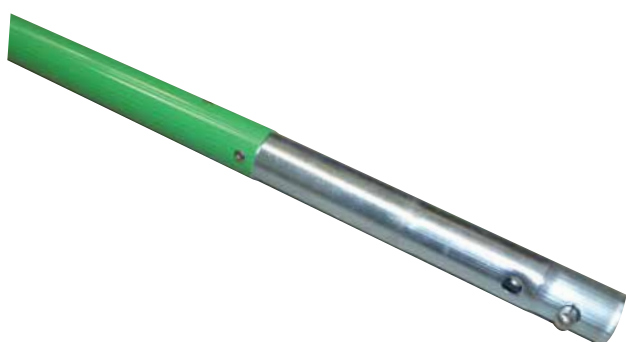

Brand	Code	Size
Master Finish	MF588	Clip together handle 2m



Brand	Code	Size
Kraft	CC289SO	1.8m x 1-3/4" dia button handle



Brand	Code	Size
Marshalltown	MT828	Hardwood handle for Spread-Krete Tool MT826



Brand	Code	Size
Ox	OX-P016550	Professional Telescopic Handle 2.7 - 5m



Brand	Code	Size
Kea	TSSBFHANDLE	1.8m x 1-3/4" dia button handle

T-Bar



Brand	Code	Description
Totalsite	409083848	Extruded high grade Aluminium for creating perfect long straight control joints, 45mm tapered cutting edge off the solid rib to tamp it down



Brand	Code	Size
Kea	TSSGOLDRAKE	500mm Anodised Heavy Duty Alloy Concrete Rake

Concrete Rakes & Spreaders



Brand	Code	Size
Marshalltown	MT826	500 x 100mm steel Spread-Krete with hook (handle not included)



Brand	Code	Size
Ox	OX-P016305	Aluminium 1500mm long handle, 762mm wide head with soft grip



Brand	Code	Size
Kraft	CC944	Aluminium head and handle 500mm wide
Kraft	CC944-30	Aluminium head and handle 750mm wide



Brand	Code	Size
Ox	OX-P016302	Aluminium 1500mm long handle 500mm wide head with soft grip



Brand	Code	Size
Kea	TSSRAKE	500mm Heavy Duty Alloy Concrete Rake



Asphalt Lutes

Brand	Code	Size
Kea	30101	700mm wooden asphalt lute
Kea	30103	900mm wooden asphalt lute



Brand	Code	Size
Kea	GG842	42" Magnesium Asphalt Lute with 7' Handle



Concrete Brooms



Concrete Brooms with Brackets

Brand	Code	Size
Ox	OX-P060390	900mm premium fibre bristles concrete broom with cast aluminium back

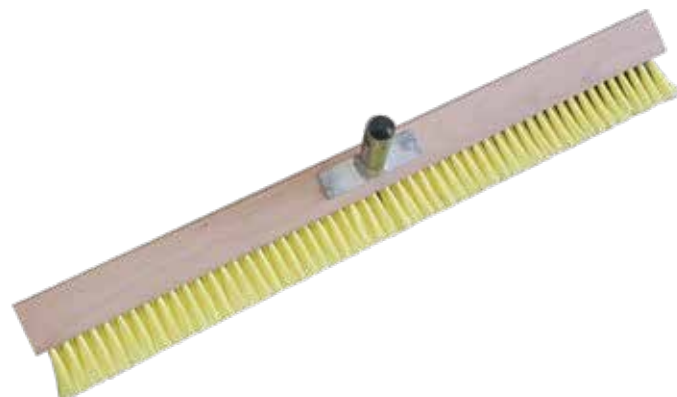

Brand	Code	Size
NZ Brush	17136	900mm soft yellow bristle concrete broom



Brand	Code	Size
Kea	TSSBROOM	Coarse Concrete Finishing Broom

Concrete Texture Roller Sleeves

TOOLS

Fine Texture

Brand	Code	Size
Almax	CA-647	460mm



Coarse Texture

Brand	Code	Size
Wooster	R233	460mm

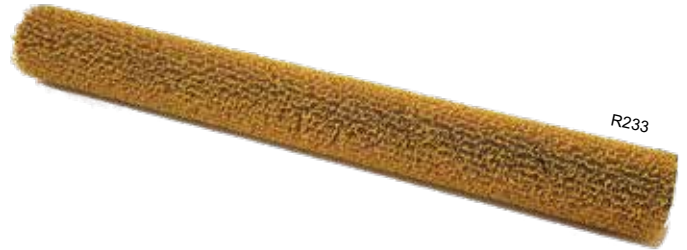

Adjustable Frame

Brand	Code	Description
Haydn	PAJUG-TP	Adjustable from 310mm to 460mm Fits telescopic handle



Wooster Pro Doo-Z Roller 450mm

Brand	Code	Size
Wooster	RR643-450	13mm NAP
Wooster	RR644-450	20mm NAP



Sponge

Brand	Code	Description
Kea	TSSSPONGE	Giant concrete sponge



Roller Tray

Brand	Code	Description
Wooster	BR412-21	500mm wide, big roll-off area for 450mm frames



Double Rollers

Brand	Code	Size
Kea	TSSROLLER	1200mm length

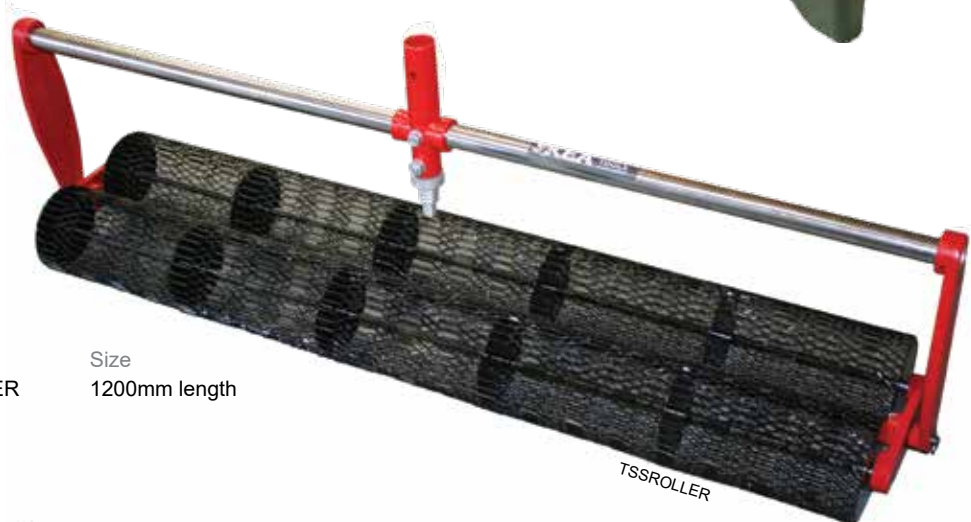

Knee Pads & Boards

Brand	Code	Description
Kea	TSSKNEEL	A portable rubber foam lined board
Marshalltown	MT451	A portable rubber foam lined board
Kneepro	EUF	Hinged with metal rivet so it moves like your knee and stays in place
CQ	18502	Budget knee pads



Rubbing Stones

Brand	Code	Description
Kea	TSSRUB	Fluted with handle
Norton	XBF24	100 x 50 x 50 fluted
Norton	XBF28	200 x 50 x 50 fluted
Norton	XBP28	200 x 50 x 50 plain
Ox	OX-P071008	Fluted with handle



Concrete Scrapers

Brand	Code	Description
Marshalltown	MT820	508 x 102mm with metal handle
Ox	OX-P050408	200mm professional H/D floor scraper
Ox	OX-T050512	300mm professional H/D floor scraper
Edma	EDM9901	150mm universal floor scraper (head only)
Edma	EDM9900	300mm universal floor scraper (head only)
Edma	EDM9950	500mm universal floor scraper (head only)
Edma	EDM9902	1100mm handle only

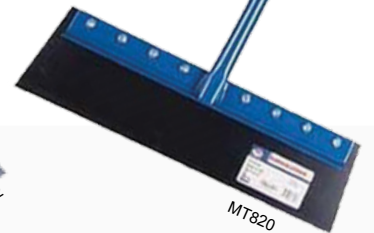

Concrete Testing Equipment



Brand: Kea
Code: TSSCONE
Description: Standard Slump Cone



Brand: Kea
Code: TSSMOULDHD
Description: Concrete Cylinder Mould (Clamping Lid) 100x200mm



Brand: Kea
Code: TSSMOULDLW
Description: Concrete Cylinder Mould (Standard Lid) 100x200mm

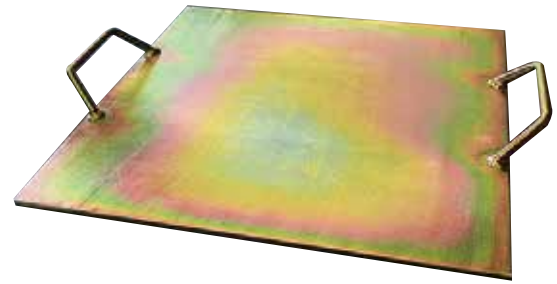

Brand: Kea
Code: TSSSLUMPPATE
Description: Standard Slump Plate 450mm x 450mm x 6mm



Brand: Kea
Code: 55-C0140/A
Description: Tamping Rod



Brand: Kea
Code: TSSSCOOP
Description: Stainless Steel Scoop



Brand: Kea
Code: TSSSLUMPKIT
Description: Slump Kit - Tray, Cone, Scoop, Tamp Rod, Collar, Thermometre, Rule)

Shovels

Round Mouth Shovel

Brand Xcel
Code SHOV046

Round mouth tubular steel 240mm shovel



Post Hole/Garden Shovel

Brand Xcel
Code XLGARDEN

Post hole/garden long ash handle 210mm shovel



Contractors Shovel

Brand Xcel
Code XLLHRM2

Contractors long ash handle 255mm shovel



Square Mouth Shovel

Brand Xcel
Code SHOV045

Square mouth tubular steel 250mm shovel



Trench Shovel

Brand Xcel
Code XLTRENCH

Trenching long ash handle 175mm shovel.



Cable Trenching Shovel

Brand Xcel
Code XLCABLE

Cable trenching long handle 100mm



Fibreglass Long Handle Round Mouth Shovel

Brand Kea
Code M67355

Fibreglass long handle, round mouth shovel



Fibreglass Long Handle Square Mouth Shovel

Brand Kea
Code M293

Fibreglass long handle, square mouth shovel





End Cutting Pliers



End Cutting Pliers

Brand	Code
Knipex	KP68-180 (180mm)
Knipex	KP68-200 (200mm)
Knipex	KP68-280 (280mm)

Head shape provides optimised movement when tightening steel mesh knots during reinforced concrete work. With cutting edges for soft and hard wire. Also suitable for twisting and cutting binding wire. Cutting edges additionally hardened; cutting edge hardness approx. 61 HRC. High-grade special tool steel; forged; oil-hardened.



Brand	Code
Channellock	CH35-250 (250mm)
Channellock	CHE358 (210mm)

Strong and reliable, Channellock Concretor's Nippers have a knife and anvil style cutting system for perfect mating and superior cutting edge life. This plier has laser heat-treated cutting edges that last longer for hard, medium hard and copper applications. Cutting capabilities include hard wire (0.047" - 0.070"), medium hard wire (0.047" - 0.091") and soft wire (0.162" max diameter). High-grade special tool steel; forged; oil-hardened.



Brand	Code
Crescent	72-9CVN

Hardened edges for longer life Top quality end cutting tool Precision Manufactured from forged alloy tool Steel Handles with carefully designed leverage ratio to blades, easier cutting Carefully designed throat clearance and rivet size.

Bolt Cutters & Benders



Bolt Cutters

Brand	Code	Description
Hit	HHBC600	600mm bolt cutters - 10mm rod
Hit	HHBC750	750mm bolt cutters - 13mm rod
Hit	HHBC900	900mm bolt cutters - 16mm rod
Hit	HHBC1050	1050mm bolt cutters - 19mm rod



Bender

Brand	Code	Description
Hit	HRC16B-6D	Cutter bender 16mm rod

Crow Bars

Brand Code
Stanway TW9009

1750mm x 30mm hex section Heavy Duty Point and Chisel Crow Bar. Ideal for loosening all types of soil in deep holes and trenches. Ends forged from high carbon steel and heat treated for strength. One sharpened chisel end and one point end.



Brand Code
Stanway TW9025

1750mm x 25mm hex section Heavy Duty Point and Chisel Crow Bar. Ideal for loosening all types of soil in deep holes and trenches. Ends forged from high carbon steel; chisel and point heat treated for strength; 1 sharpened chisel end and 1 point end. 25mm section lightens the bar weight Ideal for less arduous conditions.

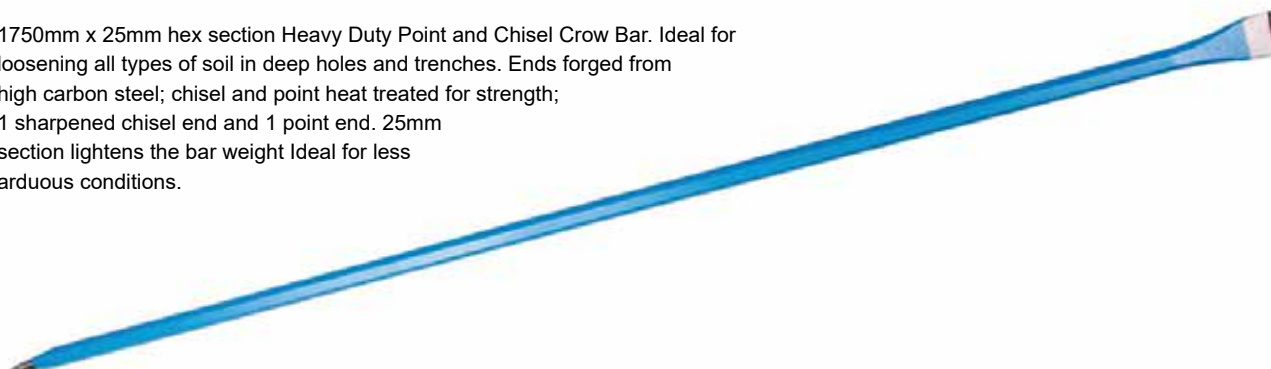

Brand Code
Kea FAICROW60-INS

1550mm x 32mm insulated crowbar made to BS8020 this chisel and point crowbar is fully insulated. Tested individually and certified to 1000volts.



Brooms & Brushware



Brooms

Brand	Code	Description
NZ Brush	72112	Household broom 300mm PVC, fits 1180 x 22mm coated handle

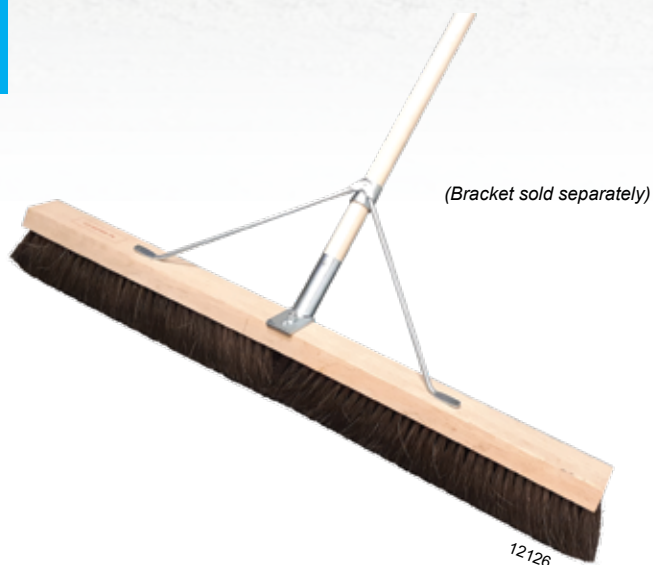

Brand	Code	Description
NZ Brush	12126	Workshop broom 610mm, java fill includes 28mm handle
NZ Brush	12138	Workshop broom 915mm java fill includes 28mm handle
NZ Brush	90352	Broom bracket



Brand	Code	Description
NZ Brush	10617	Dairy broom 405mm, white poly, very hard wearing, 28mm handle



Brand	Code	Description
NZ Brush	71703	Concrete acid wash brush with 25mm handle.
NZ Brush	71710	Head only.



Brand	Code	Description
NZ Brush	72315	350mm poly filled broom great for smooth floors includes handle
NZ Brush	72319	450mm poly filled broom great for smooth floors includes handle



Brushes

Brand	Code	Description
NZ Brush	73518	Gong brush long handle



Brand	Code	Description
Raveu	RV8017	Gong brush short handle



Brand	Code	Description
NZ Brush	80201	Brush and pan set



Brand	Code	Description
Marshalltown	MT829	Masonry slurry brush



Brand	Code	Description
NZ Brush	16108	Whitewash brush, continental den nylon softened ends for rough cast etc



Brand	Code	Description
Dixbro	SPIK402	Wire brush 4 row with plastic handle

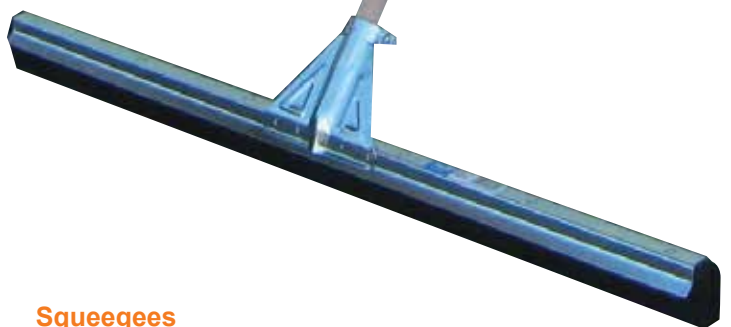

Squeegees

Brand	Code	Description
NZ Brush	20030/90345	Squeegee with double rubber blade soft 700mm and 25mm handle

Tie Wire Puller



Tie Wire Puller

Professional tie wire puller, wear resistant bronze sleeve for longer life. Leather re-coil 'stopper'. 310mm.

Brand Code
Draper DRWTD



Tie Wire Reel

Fits any standard belt. Suits all types of tie wire. Left or right hand use. Cast aluminium construction.

Brand Code
Ox OX-T299701



Wire

Code	Description
WT161102000P6	1.6mm wire ties, 2000 bundle, 110mm
WT162002000P6	1.6mm wire ties, 2000 bundle, 200mm



Tie Wire

The ultimate tie wire for concreting and general construction uses such as tying reo bars and reinforcement mesh.

Brand	Code	Description
Kea	TSSTIEWIRE	1.60mm x 1.5kg coil

Chisels & Bolsters



FP1237-075

Brand	Code	Description
Footprint	FP1237-075	Bolster chisel 225 x 75mm
Footprint	FP1237-100	Bolster chisel 225 x 100mm
Footprint	FP1237-113	Bolster chisel 225 x 113mm

Builders Lines



Brand	Code	Description
Stanway	CM40	40m braided nylon string line white
Stanway	CM80	80m braided nylon string line white
Stanway	CM80FL	80m braided nylon string line fluoro
Tuff	TSLP80	80m braided nylon string line fluoro pink
Tuff	TSLY80	80m braided nylon string line fluoro yellow

Steel Toe Rubber Gumboots

The Neo is the Gumboot of choice for heavy duty industries that require steel toe protection, insulation and warmth, whilst remaining 100% waterproof. Manufactured from a unique blend of neoprene and high density rubber for greater flexibility and robustness.

Comfortable, thermal-lined 200 joule safety toe cap, providing strength and safety protection.

Sizes 6 - 13

Brand	Code
Bison	MBBISONNR



Work Lights

Halogen Work Lamps



Brand Code
 Totalsite SHL10

Description
 Portable Halogen Flood Light 500W.

LED Battery Rechargeable Lights



Brand Code
 Intex SLB10

Description
 10W Battery LED Light. Magnetic base and 180deg folding stand. 3 hour run-time on full power.



Brand Code
 GrizzlyPro PRO20

Description
 2200 Lumens, IP65, 4 hours discharging time, rechargeable, powerbank, magnetic leg.

Brand Code
 GrizzlyPro PRO40

Description
 3800 Lumens, IP65, 4 hours discharging time, rechargeable, powerbank, magnetic leg.



Brand Code
 GrizzlyPro WOMBAT

Description
 380000 Lumens, IP65, 4 hours discharging time, 10,000mAh Li-ion battery power bank.

LED Headlamps



Brand Code
 SupFire HL33

Description
 Headlight, main light 900 lumens, auxilliary lights 300 lumens ea



Brand Code
 GrizzlyPro SCORPION

Description
 500 lumen rechargeable headlight



Brand Code
 GrizzlyPro HLW350

Description
 350 lumen headlight



Brand Code
 GrizzlyPro HLW650

Description
 650 lumen headlight

LED Corded Worklight



Brand Code
 GrizzlyPro EDGE50

Description
 6500 lumens, IP65, slim-line design yet packing a punch.



Brand Code
 Intex SLP35

Description
 35W corded LED light. 3300 lumens. 180 deg adjustable rugged stand.

Brand Code
 Intex SLP60

Description
 60W corded LED Light. 5000 lumens. 180deg adjustable rugged stand.

Tripod



Brand Code
 Intex STR21

Description
 Mountable with all Intex LED work lights .1.1m – 2.1m steel telescopic tripod. Compact folding design.

Extension Cords



Brand	Code	Description
Ox	OX-P311710	Super duty 10m extension cord
Ox	OX-P311720	Super duty 20m extension cord
Ox	OX-P311730	Super duty 30m extension cord
Intex	EL101	10m extension cord
Intex	EL102	20m extension cord
Intex	EL153	30m extension cord

Knives



Brand	Code	Description
Sterling	No.80	Economy yellow plastic cutter
Sterling	690-1	All Metal 18mm Autolock Cutter
Sterling	201-1	18mm Snap Off Blade Card 10

Lifeguard Power Box



Code LG6.4PSOA

The Lifeguard 4 is a single phase Portable Socket Outlet Assembly, available with either 10A or 15A sockets. The Lifeguard 4 meets the requirements of ASNZS 3012, and has been issued with Certificate of Approval number V05583. (Residual Current Device – Portable Type) The Lifeguard 4 is suitable for use on Building Sites. It has the specifications Tradesmen and OHS demand.

Code LG6.6PSOA

The Lifeguard 6 is a single phase Portable Socket Outlet Assembly, available with either 10A or 15A sockets. The Lifeguard 6 meets the requirements of ASNZS 3012, and has been issued with Certificate of Approval number V05583. (Residual Current Device – Portable Type). The Lifeguard 6 is suitable for use on Building Sites. It has the specifications Tradesmen and OHS demand.

Hacksaw



Brand	Code
Morse	MRHF04

A contractors hacksaw fitted with a 300mm bi-metal 24 TPI blade. Light weight rectangular section frame storage for extra blades. Tensioning screw at the handle base enables the blade to be quickly set to the correction tension.



Bi-Metal Hacksaw Blades

Brand	Code	Description
Toolware	MRHB-18	Morse hacksaw blades all sizes

Measuring Wheel

Brand Sterling
Code MW12

Records up to 9999M. 2 counter reset buttons for easy continual Use. 318mm diameter rubber grip wheel. Zero point indicator for accurate measuring. 120cm length folds down to 60cm. Trigger brake prevents 'free wheeling' Net weight 2.05kg. Supplied with carry bag.



Cement Scarifier

Brand	Code	Size
Marshalltown	MT722	200mm
Marshalltown	MT723	300mm



Hammers



OX-P080725

Scutch

Brand	Code	Description
Ox	OX-P080528	Bricklayers single scutch
Ox	OX-P080725	Scutch Comb 25mm
Ox	OX-P080738	Scutch Comb 38mm
Ox	OX-P080750	Scutch Comb 50mm



Bricklayers

Brand	Code	Description
Ox	OX-P082424	Accurately Ground Chisel End For Clean Cutting. Handle With Shock Reduction
Ox	OX-T081024	340mm handle length, 24oz, fibreglass handle



Claw

Brand	Code	Description
Estwing	E-MRF20C	Sure Strike 20oz
Estwing	E-MR20C	Estwing 20oz
Ox	OX-P080120	Ox 20oz with Duragrip handle



Club

Brand	Code	Description
Barco	BA05-2'	Forged head 3 lb
Barco	BA0F	Forged head 4 lb



Sledge

Brand	Code	Description
Excel	SLEDGE8	Hickory handle 8lb
Excel	SLEDGE10	Hickory handle 10lb
Excel	SLEDGE8FG	Fiberglass handle 8lb
Excel	SLEDGE10FG	Fiberglass handle 10lb
Field	FR200	Steel handle 60mm rubber head



Marking Equipment



ST47-681



ZE81921-1

GIANTLINE



KSK1

Chalk Lines

Brand	Code	Description
Stanley	ST47-681	4oz chalk and line level set 30m
Keson	KSK1	45m chalk line reel
Stanway	ZE81921-1	30m chalk line set
Giantline	GIANTLINE	50m refillable chalk line



Chalk Refill

Brand	Code	Description
Hansen	HN4B	Blue 4oz Refill chalk for self-chalking reels.
Hansen	HN4R	Red 4oz Refill chalk for self-chalking reels.
Hansen	HN4Y	Yellow 4oz Refill chalk for self-chalking reels.

Carpenters Pencils

Brand	Code	Description
Blackedge	BP218H	Hard lead
Blackedge	BP218M	Medium lead



Marking Crayons

Brand	Code	Colour
Retsol	MC100BK	Black
Retsol	MC100BL	Blue
Retsol	MC100G	Green
Retsol	MC100R	Red
Retsol	MC100W	White
Retsol	MC100Y	Yellow



Permanent Markers

Brand	Code	Colour
Bic	VIVIDB	Blue vivid fine tip
Bic	VIVIDBL	Black vivid fine tip



Spray Paint

Brand	Code	Colour
Tradegear	50013529	Pink
Tradegear	50013526	Orange
Tradegear	50013525	Yellow



Spray Bottles



Brand	Code	Description
Totalsite	GPPUMP500	500ml spray bottle PVC
Totalsite	GPPUMP1000	1L spray bottle PVC
Totalsite	GPPUMP125	1.25L spray bottle PVC

Measuring Products

Brand	Code	Description
Lawfords	MEAS100	100ml measuring cylinder
Lawfords	MEAS250	250ml measuring cylinder
Lawfords	EJUG1L	High quality plastic 1L jug
Lawfords	EJUG2L	High quality plastic 2L jug
Lawfords	EJUG3L	High quality plastic 3L jug
Lawfords	JUG1L	Mini plastic 1L jug
Lawfords	JUG3L	Mid plastic 3L jug
Lawfords	JUG5L	Maxi plastic 5L jug



Tape Measures



Brand	Code	Description
Sterling	TBC8025	8m x 25mm metric rubber sides
Sterling	TBC1025	10m x 25mm metric rubber sides
Sterling	FR8033	8m Fat Rhino Tape

Carpenters Rules



Brand	Code	Description
Fisco	HU59W-18	1m bevel edge 4 fold 5mm white nylon
Fisco	HU59Y-16	1m square edge 4 fold 5mm yellow nylon

Abrasive Files



Abrasive Files

Brand	Code	Description
Surform	ST21-296	Plane 250mm
Surform	ST21-295	Flat File 250mm
Surform	ST21-293	Replacement standard blade

Fasteners & Ratchets



FY123-8



FY122-8



FY124-8

1m Fasty Strap

Description
Polypropylene Loading and lashing straps. Suitable for light commercial and domestic lashing applications. With a rated strength of 400kg. 25mm width.

Brand	Code	Colour	Length
Toolware	FY121-8	White	1m
Toolware	FY122-8	Yellow	1.5m
Toolware	FY123-8	Blue	2m
Toolware	FY124-8	Red	2.5m
Toolware	FY125-8	Black	3.5m



Professional 25mm x 4m Ratchet Tie Down Strap - 4 Pack

Description
25mm x 4m blue polyester webbing. 4 pack. 250kg lashing capacity. Vinyl coated 'S' hooks at each end.

Brand	Code	Colour
Ox	OX-P200904	Blue



50mm x 9m Tiedown Ratchet 2500kg

Description
50mm x 9m Tiedown Ratchet 2500kg.

Brand	Code	Colour
Totalsite	TSSTIEDOWN	Blue



EQUIPMENT



RAPTOR

The Raptor brand has been known for its matchless performance in quality and reliability, displayed through its perfected design along with a genuine Honda engine will offer you many years of high quality trouble-free performance.



EQUIPMENT

Raptor Power Trowels

Raptor Power Trowel 24"

Code TSS24

This compact design is ideal for finishing edges and around risers. Honda GX160 Motor. Only 24 inches (610 mm) in diameter making it great for finishing tight spaces and around obstructions.

- 24-inch machine features a 620mm guard ring diameter.
- Centre mounted lifting hook attached to arm.
- Perfected engine balance allows for a smooth and accurate finish.
- 4 blade machine.
- Weight of 50kg.
- Handle mounted kill switch for safe handling.
- 12 months warranty.
- Heavy duty gear box designed for a long-life performance.
- Machine is power by a genuine Honda GX160 (4.8 horsepower)
- Accurate (Knob type) pitch control
- Foldable arm allows for easy handling, transport & storage.



Raptor Power Trowel 34"

Code TSS34

Ideally suited for small to medium slabs.
Powered by a reliable Honda engine.

- 34-inch machine features a 970mm guard ring diameter.
- Centre mounted lifting hook.
- Robust arm and framework allows great performance for tough work conditions.
- Perfected engine balance allows for a smooth and accurate finish.
- 4 blade machine.
- Weight of 76kg.
- Handle mounted kill switch for safe handling.
- 12 months warranty.
- Heavy duty gear box designed for a long-life performance.
- Machine is power by a genuine Honda GX160 (4.8 horsepower)
- Comes with accurate (Knob type) pitch control



Raptor Power Trowel 36"

Code TSS36

Ideally suited for small to medium slabs.
Powered by a reliable Honda engine.

- 36-inch machine features a 970mm guard ring diameter.
- Centre mounted lifting hook.
- Machine is power by a genuine Honda GX270 (9 horsepower)
- Weight of 85kg.
- 12 months warranty.
- 4 blade machine.
- Premium spider arm design and perfected engine balance allows for a smooth and accurate finish.
- Rotor speed 0-150 RPM.
- Handle mounted kill switch for safe handling.
- Comes with foldable wheels making it possible to be operated by one person.
- Accurate (Knob type) pitch control
- Heavy duty gear box designed for a long-life performance.
- Weight of 85kg.
- Perfected engine balance allows for a smooth and accurate finish.
- Robust arm and framework allows great performance for tough work conditions.



Raptor Power Trowel 40"

Code TSS40

Ideally suited for small to medium slabs. Powered by a reliable Honda engine.

- 40-inch machine features a 1050mm guard ring diameter.
- 12 months warranty.
- Heavy duty gear box designed for a long-life performance.
- Handle mounted kill switch for safe handling.
- Centre mounted lifting hook.
- (Knob type) pitch control
- 4 blade machine.
- Machine is power by a genuine Honda GX160 (4.8 horsepower)
- Weight of 85kg.
- Perfected engine balance allows for a smooth and accurate finish.
- Robust arm and framework allows great performance for tough work conditions.



Raptor Power Trowel 46"

Code TSS46

Ideally suited for small to medium slabs. Powered by a reliable Honda engine.

- 46-inch machine features a 1220mm guard ring diameter.
- Centre mounted lifting hook.
- Powered by a genuine Honda GX270 (9 horsepower)
- 4 blade machine.
- Premium spider arm design and perfected engine balance allows for a smooth and accurate finish.
- Handle mounted kill switch for safe handling.
- 12 months warranty
- Rotor speed 0-145 RPM.
- Heavy duty gear box designed for a long-life performance.
- Weight of 100kg.
- Comes with accurate (Knob type) pitch control



Raptor 36" Premium Ride On Power Trowel

Code TSSRIDE36

This Ride-on Raptor 36-inch features powerful Honda GX690 (22 horsepower) engine. With twin stick multi-directional steering system provides precision control. Tight tolerance spider plate assemblies provide a high quality well balanced machine for a smooth and accurate finish.

Specifications

- Twin 36-inch machine features a 1910mm working diameter.
- Machine is power by a genuine Honda GX690 (22 horsepower)
- Heavy duty gear box designed for a long-life performance.
- Premium spider arm design and perfected engine balance allows for a smooth and accurate finish.
- Comes with twin (Knob type) pitch control for accurate finishing.
- Rotor speed 0-150 RPM.
- Weight of 345kg
- Heavy duty guard ring with built in LED lights with an electric spray System for water/Retarder.
- Quick release front panel and in-built toolbox makes it easy for mechanical and blades servicing.
- Four blades per rotor.
- Variable speed clutch and foot mount kill switch makes it easy for safe and precision handling.



MBW Power Trowels

MBW walk-behind power trowels feature the industry's heaviest bearings, output shafts, gears, spiders and blade arms. Comparison of these critical MBW components to those of any competitor answers the question as to why MBW trowels run so well for so long.

Tool free height adjustable operator handle. ISO compliant, low profile guard ring allows for easy cleaning and blade changes.

EQUIPMENT

MBW Power Trowel 36"

Code 36HLLV

Ideally suited for small to medium slabs.
Low vibe system, reliable Honda engine.

- 37.5" diameter
- 70-135rpm trowel speed
- 35.5" (90cm) blade sweep diameter
- 35.8" min - 43.3" max low vibration handle height
- 85 - 105 dBA noise level
- Weight 95kg



Low Vibe System

MBW Power Trowel 46"

Code 46HLLV

Ideally suited for small to medium slabs.
Low vibe system, reliable Honda engine.

- 47.6" diameter
- 70-135rpm trowel speed
- 46" (117cm) blade sweep diameter
- 35.8" min - 43.3" max low vibration handle height
- 85 - 105 dBA noise level
- Weight 112kg



Finishing Blades Super Blue Steel

Suitable for Bartell, Barikell, Wacker, Allan Razor Back, Whiteman, Raptor

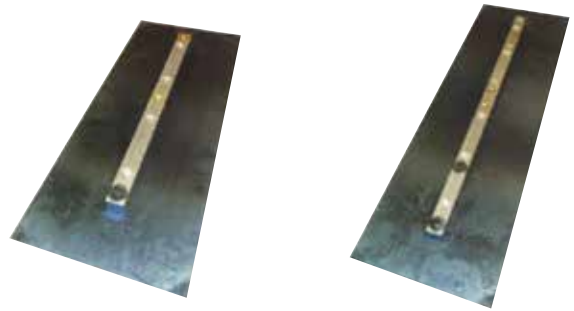

Code: SFB061416
To suit 36"

Code: SFB061816
To suit 46"

Finishing Blades

Finishing Blades - Standard

Suitable for Bartell, Barikell, Wacker, Allan Razor Back, Whiteman, Raptor



Code: CFB061416
To suit 36"



Code: CFB061816
To suit 46"

Suitable for Flex Tool, Masterfinish, Raptor



Code: TSS34B
To suit 34"



Code: TSS40B
To suit 40"



Code: TSS24B
To suit 24"



Code: PFB061420P
To suit 36"

Code: PFB061820P
To suit 46"

Combination Blades

Suitable for Flex Tool, Masterfinish, Raptor



Code: TSS24B
To suit 24"



Code: TSS34-18
To suit 34"

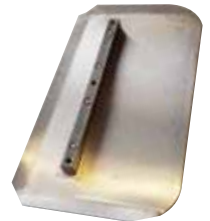

Code: CCB0814
To suit 36"

Suitable for Bartell, Barikell, Wacker, Allan Razor Back, Whiteman, Raptor



Code: TSS40-18
To suit 40"

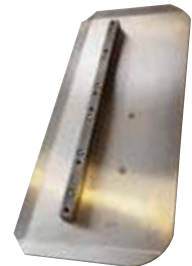

Code: CCB0818
To suit 46"

Combination Plastic Blades

Suitable for Bartell, Barikell, Wacker, Allan Razor Back, Whiteman, Raptor

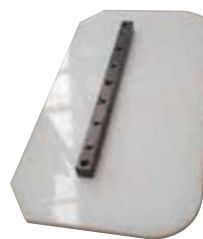

Code: PCB0814
To suit 36"



Code: PCB0818
To suit 46"

Pan Floats

Suitable for 5 blade machines



Code: TSSPAN
To suit 46" incl safety latches

Suitable for 4 blade machines



Code: TSSPAN-4008
To suit 40"



Code: TSSPAN-4608
To suit 46"



Code: TSSPAN-3608
To suit 34" & 36"



Code: TSSPAN24
To suit 24"

Concrete Vibrators

Oztec Concrete Vibrator Motors - Electric

The motors for Oztec electric concrete vibrators are manufactured to exacting specifications to withstand the rough day to day abuses associated with construction sites. Lightweight, compact and fitted with our comfortable adjustable shoulder strap, this one man power unit will speed through the stiffest concrete. Combine power units with any of Oztec's steel or rubber vibrator heads for maximum productivity. Oztec power units come standard with the Quick Disconnect "QD" system. Changing shafts and heads on the job is a snap. Tough, Rugged, and Durable! Oztec's design has been extensively tested and used on-the-job for over thirty years. The wrap around protective frame and shock absorbers effectively protect Oztec motors from damage even when dropped or thrown from heights of over six feet.

Brand	Code	Size
Oztec	3.2OZ	3.2hp motor
Oztec	2.4OZ	2.4hp motor
Oztec	1.8OZ	1.8hp motor



All Oztec Power Units (gas and electric) run vibrator heads 11,000 to 12,000 vpm. They never drop below 10,000vpm even in the lowest slump concrete (near 0) when maximum head size specifications are followed.

Oztec Petrol Engine Backpack Vibrator

Code BP50A

Runs heads up to 2 1/2" diameter. Honda 2 1/2 HP, 4 stroke, weight 24lbs. The BP-50a is equipped with a totally enclosed rotary throttle and a conveniently located kill switch on the same handle.



Flexible Shafts

Oztec Flexible Shaft inner cores are made from extra-high carbon steel wires with castings made from tough abrasion resistant neoprene rubber, reinforced with multiple layers of high tensile wire braiding with a hardened flat steel liner.



Flexible Shafts

Brand	Code	Length
Oztec	FS02OZ	0.3m
Oztec	FS05OZ	1.5m
Oztec	FS07OZ	2.1m
Oztec	FS10OZ	3.0m
Oztec	FS12OZ	3.6m
Oztec	FS14OZ	4.2m
Oztec	FS16OZ	4.8m
Oztec	FS18OZ	5.4m
Oztec	FS21OZ	6.4m

Flexible Shafts - Pencil (to suit 19mm heads only)

Brand	Code	Length
Oztec	FSP03OZ	0.9m
Oztec	FSP06OZ	1.8m
Oztec	FSP09OZ	2.7m
Oztec	FSP11OZ	3.3m
Oztec	FSP15OZ	4.5m
Oztec	FSP20OZ	6.0m

Steel Heads

Oztec Vibrator Heads produce the highest amplitude and centrifugal force, generating the largest radius of influence of any heads available.

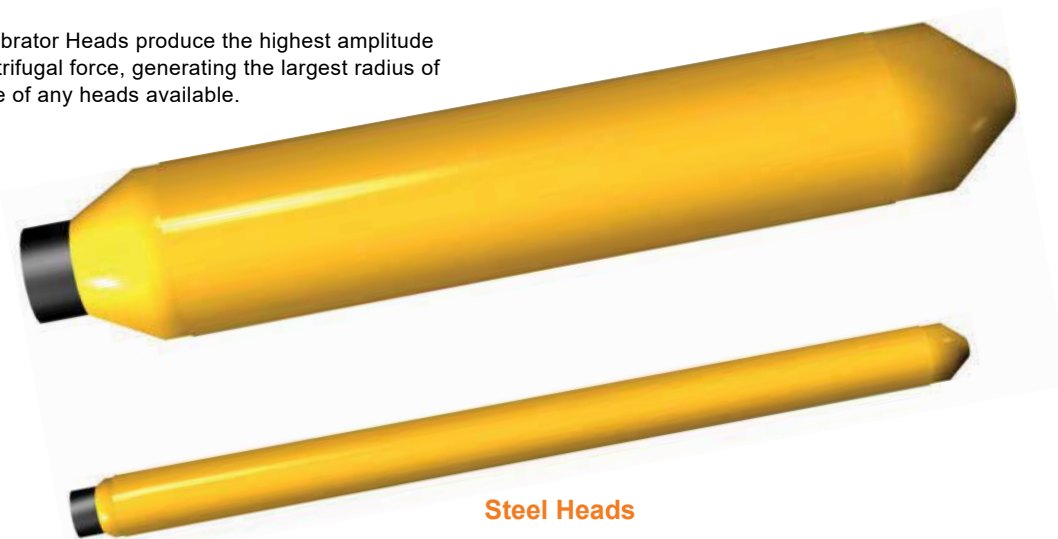

Steel Heads

Brand	Code	Size
Oztec	HP075OZ	¾" x 12" (pencil head) 19mm
Oztec	H10OZ	1" x 13" 25mm
Oztec	H125OZ	1¼" x 13" 31mm
Oztec	H150OZ	1½" x 14" 37mm
Oztec	H175OZ	1¾" x 14" 44mm
Oztec	H200OZ	2" x 14" 50mm
Oztec	H250OZ	2½" x 13" 63mm

Honda TSSVibe

Code TSSVIBE

A must have for every concrete contractor! Honda powered GX35 OHC 4-stroke engine. Quiet operation, easy starting and being 4-stroke there is no mixing fuel!! Vibrating concrete has never been so easy – no electric cords to get in the way and no power source required!! Great for remote concrete construction sites. 45mm head.



EQUIPMENT

Jeonil Pistol Vibrators

Handy vibrator is portable and multi purpose high cycle eccentric vibrator. It is lightweight and easy to handle so it can be useful everywhere.

Brand	Code	Description
Jeonil	JHV-32-1.5	32mm head 1.5m shaft
Jeonil	JHV-28-1.5	28mm head 1.5m shaft
Jeonil	JHV-32-1.0	32mm head 1.0m shaft
Jeonil	JHV-28-1.0	28mm head 1.0m shaft



Mikasa Portable Electric Hand-held Concrete Vibrator

Code MGX

Mikasa MGX series are ideal for smaller pours and hard to reach places. Block walls, footings, steps and smaller house floors is where the MGX fits. Available in with a 1m or 2m shaft and 2 head sizes the MGX will suit any contractor or hire company.



Vibrastrike II Power Screed

The Vibrastrike II power screed features a four-stroke engine. One-piece design of the two-in-one float eliminates more than 60 nuts, bolts, studs, washers, tensioning rods and brackets for improved overall functionality.

Unique geometric shape of the float allows use as both a float and curl edge when screeding from the top of forms. 1.5hp Honda GX35 engine.



Brand	Code	Description
Vibrastrike	LIN-VS0098	Vibrastrike II Power Screed
Vibrastrike	LIN-F4-FLOAT-4	Vibrastrike II 4' Magnesium Closed Bar 1.2m
Vibrastrike	LIN-F4-FLOAT-5	Vibrastrike II 5' Magnesium Closed Bar 1.52m
Vibrastrike	LIN-F4-FLOAT-6	Vibrastrike II 6' Magnesium Closed Bar 1.8m
Vibrastrike	LIN-F4-FLOAT-8	Vibrastrike II 8' Magnesium Closed Bar 2.4m
Vibrastrike	LIN-F4-FLOAT-10	Vibrastrike II 10' Magnesium Closed Bar 3.0m
Vibrastrike	LIN-F4-FLOAT-12	Vibrastrike II 12' Magnesium Closed Bar 3.6m
Vibrastrike	LIN-F4-FLOAT-14	Vibrastrike II 14' Magnesium Closed Bar 4.2m

MBW ScreeDemon

MBW's ScreeDemon™ is one of the most innovative and ergonomically friendly wet screeds on the market. We are excited to announce that we have partnered with Milwaukee Tool in developing our first electric version of the ScreeDemon™ Powered by M18™ REDLITHIUM™ battery. Along with it being the easiest screed to assemble, it is now the easiest to run wet screed on the market. Quieter than an engine version. Lights improve visibility in darker work areas. Zero emissions makes it perfect for indoor work. Clamp system makes assembly and disassembly fast and easy. Sealed exciter requires no maintenance. Hand / arm vibration is 50 to 90% less than the competition.



Brand	Code	Description
MBW	500MLP	MBW Battery ScreeDemon (Battery & Charger not included)
MBW	17804	ScreeDemon Scree Bar 4ft/1.2m
MBW	17806	ScreeDemon Scree Bar 6ft/1.8m
MBW	17808	ScreeDemon Scree Bar 8ft/2.4m
MBW	17810	ScreeDemon Scree Bar 10ft/3m
MBW	17812	ScreeDemon Scree Bar 12ft/3.6m
MBW	17814	ScreeDemon Scree Bar 14ft/4.2m

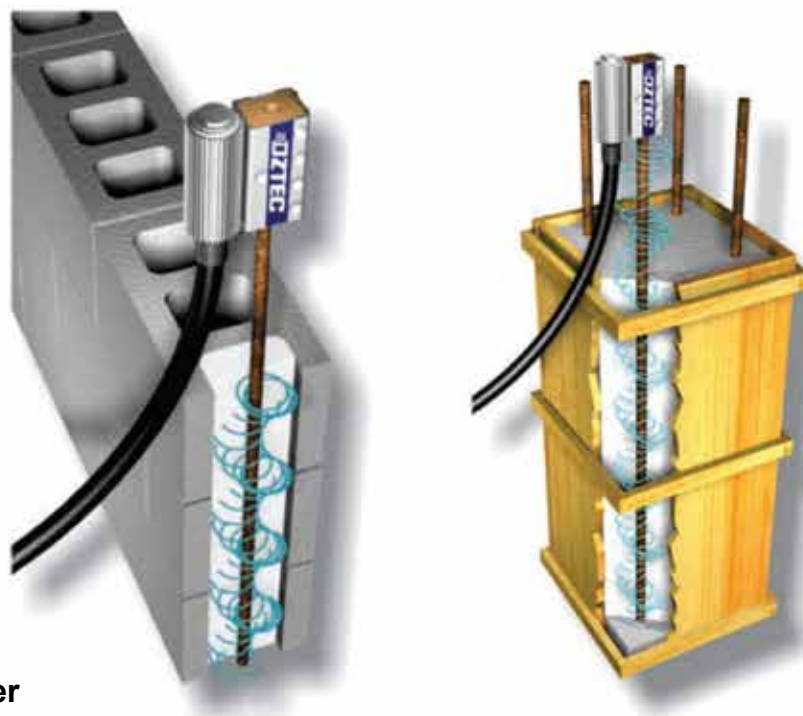

Oztec Rebar Shaker

Code HRBS

Eliminate the time and mess of lowering a concrete vibrator into a cell containing a rebar and filled with grout. The splashes caused by the withdrawal of the vibrator are slippery, dangerous and time consuming to clean up. The Rebar Shaker simply slipped over the top of the rebar, vibrates and consolidates grout in 5 to 7 seconds. Tremendous savings in man-hours, from filling and refilling cells, clean-up and lost time due to injury from slips and falls are realized through the use of the Rebar Shaker.

Compaction Equipment

HP50 Plate Compactor

Code KP55

An ideal plate compactor for a wide range of smaller jobs - pathways, paving, driveways, drainage... Easily loaded in and out of vehicles. A transport friendly model, now with folding handles, designed to fit in most medium side vehicles.

Hard working Miewa Plate Compactor powered by Honda Engine.

- 60kg weight
- 3.2kw
- Honda GX120 3.5hp engine
- 495 x 350mm plate size



HP60 Plate Compactor

Code KP60

The perfect mid-range plate compactor for a wide range of demanding small to medium size jobs - pathways, paving, driveways, drainage...etc. Hard working plate compactors powered by Honda Engines.

- 67kg weight
- 3.2kw
- Honda GX120 3.5hp engine
- 525 x 350mm plate size



HP80 Plate Compactor

Code KP80

The perfect mid-range plate compactor for a wide range of demanding small to medium size jobs - pathways, paving, driveways, drainage...etc

- Honda GX160
- 4.8hp Engine
- Weight 82kg
- Plate Size 585 x 400mm
- Traveling Speed 22-25 m/min
- Vibration Frequency 100.0Hz (6000vpm)
- Centrifugal Force 13.5Kn (1380kgf)
- 3.6L Fuel Tank



Reversible Plate Compactor

Code RP100

This machine is used for the compaction of sandy/gravelly soil in trenches and foundations as well as paving applications.

- 115kg
- 4.2kw
- Robin EX17D engine
- 570 x 380mm plate size
- 4500vpm
- 3.6L fuel capacity
- Recoil starter



Reversible Plate Compactor

Code RP60

This reversible plate compactor is used for the compaction of sandy/gravelly soil in trenches and foundations as well as paving applications.

- 70kg
- 3.2kw
- Robin EX13D engine
- 470 x 350mm plate size
- 5600vpm
- 2.7L fuel capacity
- Recoil starter



Reversible Plate Compactor

Code RP150

This machine is used for the compaction of sandy/gravelly soil in trenches and foundations as well as paving applications.

- 150kg
- Honda GX160 5.0hp Engine
- 630 x 390mm plate size
- 4200vpm
- 3.1L fuel capacity
- Recoil starter



Tamping Rammer RTX60D

Code RTX60D

MEIWA tamper and vibratory rammers are specifically designed for easy, smooth operation. The simplified design requires little maintenance giving you higher productivity and increased availability. All models feature a low centre of gravity for stability and ease of operation.

- 63kg
- 2.1kw
- Robin EH09-2D engine
- 330 x 230mm plate size
- 40-60mm impaction stroke
- 730L x 385W x 1010H dimension (mm)
- 2.5L fuel capacity



Tamping Rammer RTX80D

Code RTX80D

MEIWA tamper and vibratory rammers are specifically designed for easy, smooth operation. The simplified design requires little maintenance giving you higher productivity and increased availability. All models feature a low centre of gravity for stability and ease of operation.

- 80kg
- 2.6kw
- Robin EH12-2D engine
- 330 x 300mm plate size
- 40-60mm impaction stroke
- 730L x 430W x 1035H dimension (mm)
- 2.5L fuel capacity



Pole Tamper

Ergo Tamp

Code 786C

MBW has tamed one of the industry's most disliked and physically abusive compaction tools. Pneumatic Tampers (also known as "Pole Tampers", "Pogo Sticks" and "Bouncing Betties") produce hand/arm vibration levels that rank among the highest in the industry. Periodic exposure to excessive vibration is known to be a contributing factor in the development of white finger, carpal tunnel syndrome, arthritis and other chronic ailments.

The ERGO-TAMP™ reduces hand arm vibration up to 70%, allowing for some variation as conditions of compaction change. The vibration absorption system easily handles the range of amplitudes typical of pneumatic tampers and is cooled by a constant flow of compressed air through its working mechanism.

By rendering the pneumatic tamper tolerable from an operational point-of-view, users are less prone to terminate the compaction effort before reaching a satisfactory geotechnical result. An improved compaction effort results in a lower incidence of pavement failure. Reduced hand/arm vibration results in less wear and tear on the personnel who get the job done.

Optional trigger guard prevents accidental tool activation.



Grout Pumps

Totalsite Supplies is New Zealand's supplier of ChemGrout Grout Pumps. Chemgrout has manufactured the world's largest selection of grouting equipment for more than 50 years.

Manual Hand Grout Pump

Code CG-050M

The most powerful hand grout pump in the industry, the 050M provides more than 200 psi. of injection pressure. The heavy-duty Model CG-050M is an easy to use, skid mounted hand pump designed for smaller jobs using high viscosity slurries and most pre-packaged grouts. Its rugged, lightweight aluminium construction offers mobility in areas where no air or electric power sources are available.



Chemgrout Air Powered Grout Pump

Code CG-050

The Chemgrout model CG-050 is a portable, skid mounted, air powered grout pump. The lightweight aluminium construction makes this model portable for hard to reach jobs. The holding hopper is connected directly to the suction of the grout pump to provide a continuous pumping operation. The grout pump is a 2" positive displacement, pulsating piston. This grout pump is available with either an air or hydraulic cylinder to power the pump. All components are easily accessible for operating, cleaning and maintenance.



MSB Form - Adjustable Formwork Solution

MSB Form is an adjustable formwork solution for the concrete construction industry, designed to be compact, lightweight, and strong for all conditions and applications – commercial, industrial, residential and civil.

MSB Form is made of the highest quality zinc-plated steel and is designed to be lightweight, compact and extremely strong for all conditions. You can expect maximum results throughout the slab process, whether you're using MSB Form for slab on grade, fixing down to concrete or plywood.

Improve efficiency and safety, reduce labour and consumables ensuring a cost-effective business model with our adjustable concrete forms.

Frames A, B & C

Ideal for for conventional and monolithic slabs, 310mm and 385mm waffle, 150mm -500mm slab on grade. Frames connect and stack up to 1.2 metres tall. Can be fixed to concrete, plywood and ground.

Frame D

Ideal for tilt panel construction, frame height: 175mm Slab on deck 20mm podium deck. Arm extends out 28cm. Can be used with hinge insert (sold separately) great for bridge decks, ensuring you achieve between 45° - 145° on your edge form. Can be fixed to concrete, plywood and ground.

For use on: brick ledge / rebate, curbs, slab-on-grade, monolithic slabs, paving, radius pours, tank pads, tilt-up slabs, turn-down slabs.

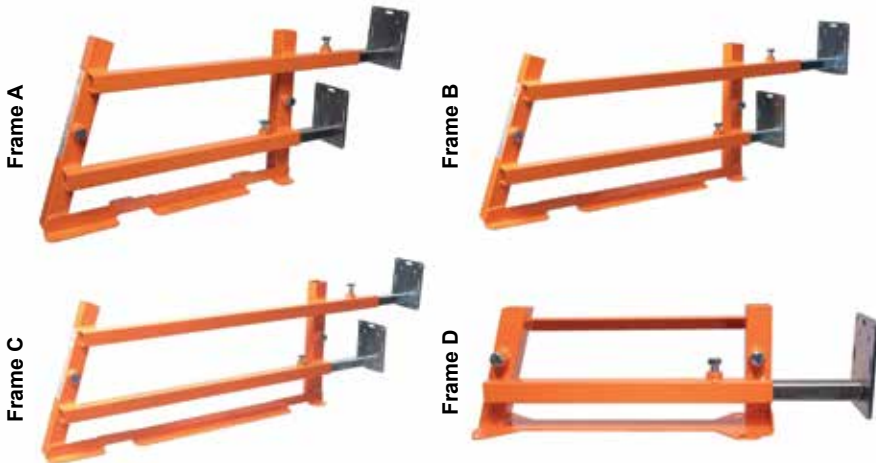

**FRAMES
RE
STACKABLE**



Tuff-Form Plastic Boxing

Designed to replace heavy wet timber that warps and twists and requires nailing to pegs.

Tuff-Form™ Plastic Boxing is lightweight boxing which is extremely fast and easy to set up and remove. It has superseded heavy wet timber that was previously used, that warped and twisted and required nailing to pegs.

Tuff-Form™ saves you money due to the speed in which it can be set up which makes your projects more efficient. While timber boxing gets disposed of after a couple of pours, Tuff-Form™ can last more than 10 years giving you reusable boxing for many years to come.

Flexible Boxing

Perfect for boxing around curves, simply mark the curve out with the pegs and then bend the formwork around them quickly and easily attaching to the peg/pin with the camlocks. No more trying to cut, soak and manipulate wood into a curve, with innovative Tuff-Form™ flexible boxing get seamless curves in an instant while bending to almost any angle. One connector required per length (5.5m) and one camlock required approx every 600-700mm.

Rigid Boxing

Provides a strong rigid length for boxing along straight sections. Easily installed in tandem with the Flexible boxing to build paths that have both curved and straight sections. Tuff-Form™ rigid boxing makes straight paths and driveways etc a breeze with only one connector required per length (5.5m) and one camlock required approx every 600-700mm.

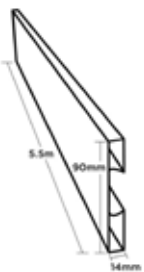

90mm Super Flex

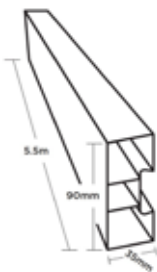

90mm Flex

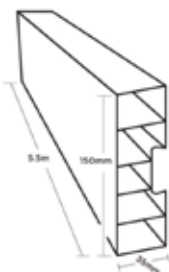

150mm Flex



200mm Flex



300mm Flex

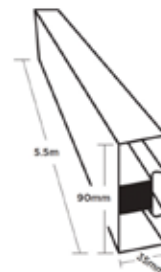

90mm Rigid

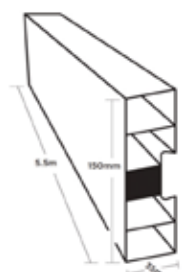

150mm Rigid



Floor Saws

Diacut 350mm Concrete Cutter

Code TSS350

This Diacut TSS350 Concrete saw is powered by a Genuine Honda GX270 engine which guarantees many years of reliable operation. This machine is designed for cutting both concrete and asphalt. With Diacut's light weight design and powerful engine this saw offers you fast and accurate cuts and countless years of trouble- free performance.

- Powered with a Genuine Honda GX270 petrol engine.
- Up to 350mm blade size, (110mm max cutting depth)
- 25.4 mm arbor size
- Lifting hook for easy handling.
- (knob type) pitch control for accurate blade depth.
- Mounted Depth indicator.
- 12 month warranty.
- Adjustable arm height for operational comfort.
- Rubber mounted shock assembly allows for smooth cutting and low vibration.
- 15L water tank.
- 70kg weight



Diacut 450mm Concrete Cutter

Code TSS450

This Diacut TSS450 Concrete saw is powered by a Genuine Honda GX390 engine which guarantees many years of reliable operation. This machine is designed for cutting both concrete and asphalt. With Diacut's heavy duty design and powerful engine this saw offers you fast and accurate cuts and built strong for construction work giving you countless years of trouble- free performance.

- Features/Specifications:
- Powered with a Genuine Honda GX390 petrol engine
- 25.4 mm arbor size
- 12 month warranty
- (knob type) pitch control for accurate blade depth
- Mounted Depth indicator
- Rubber mounted shock assembly allows for smooth cutting and low vibration
- 15L water tank
- Lifting hook for easy handling
- Up to 450mm blade size, (160mm max cutting depth)
- Adjustable handle height for operational comfort
- 95kg weight



Angle Grinders

Makita 125mm Concrete Planer

Code PC5000C

Electronic control allows for use of powerful 1,400W motor. Soft start suppresses start-up reaction. Easy-to-operate large type trigger switch.

Max Capacity: 125mm
No Load Speed: 10,000rpm
Continuous Rating Input: 1,400W



Makita 840W Angle Grinder 115mm

Code 9557NB

High performance 840 watt motor with enough power to handle all the jobs required of a small angle grinder.

Spindle Thread: M14 x 2
No Load Speed: 11,000rpm
Continuous Rating Input: 840W



Makita 840W Angle Grinder 125mm

Code 9558NB

High performance 840 watt motor with enough power to handle all the jobs required of a small angle grinder.

Spindle Thread: M14 x 2
No Load Speed: 11,000rpm
Continuous Rating Input: 840W



Makita 1,100W Angle Grinder 125mm with Paddle Switch

Code 9565P

Slim ergonomical design, heavy duty gearbox, SJS system protects operator if tool is jammed in workpiece.

Spindle Thread: M14 x 2
No Load Speed: 12,000rpm
Continuous Rating Input: 1100W



Makita 1,100W Angle Grinder 125mm
Code GA5040

Super Joint System II developed for effective vibration absorption.

Spindle Thread: M14 x 2
No Load Speed: 11,000rpm
Continuous Rating Input: 1100W



Makita 2,200W Angle Grinder 230mm
Code GA9060

Low vibration rear handle & rubberised soft-grip enhances operator comfort and control. Powerful 2,200W motor.

Spindle Thread: M14 x 2
No Load Speed: 6,600rpm
Continuous Rating Input: 2200W



Makita 2,300W Angle Grinder 230mm
Code GA9040S01

Low vibration rear handle & rubberised soft-grip enhances operator comfort and control. Powerful 2,300W motor. Soft start. Rotatable rear handle for cutting operation.

Spindle Thread: M14 x 2
No Load Speed: 6,600rpm
Continuous Rating Input: 2300W



Dust Collecting Wheel Guard 125mm
Code 195239-9

Dust Collecting Hood For 115mm and 125mm Angle Grinders. Effective suction thanks to revolving brushes at the bottom. Housing made of shockproof plastic.



Dust Collecting Wheel Guard 180mm
Code 195386-6

Standard hose fitting will work with most vacuum systems (OD 1-7/16"). Ideal for concrete finishing, concrete material removal and paint or surface coating removal.



Concrete Demolition

Makita Demolition Breaker 30mm Hex Shank

Code HM1317C

Shank Type 30mm Hex
Blows Per Min: 730 – 1450 ipm
33.8 joules
715mm length
17kg weight
1510W continuous rating input



Makita Demolition Breaker 28.6mm Hex Shank

Code HM1812

Shank Type 28.6mm Hex
Blows Per Min: 870 ipm
72.8 joules
843mm length
32.2kg weight
2000W continuous rating input



Makita Demolition Breaker Kit with Trolley

Code HM1812X4

Shank Type 28.6mm Hex
Blows Per Min: 870 ipm
72.8 joules
843mm length
32.2kg weight
2000W continuous rating input



Makita Demolition Hammer SDS

Code HM0871C

Shank Type SDS Max
1,100 – 2,650ipm blows per minute
11.6 joules
466mm length
5.6kg
1,110W continuous rating input



Makita Demolition Hammer SDS Max

Code HM1203C

Shank Type SDS Max
 950 – 1,900ipm blows per minute
 25.5 joules
 466mm length
 9.7kg
 1,510W continuous rating input



Makita Demolition Hammer SDS Max

Code HM1214C

Shank Type SDS Max
 950 – 1,900ipm blows per minute
 25.5 joules
 700mm length
 12.3kg
 1,510W continuous rating input



Rotary Hammers

Makita 28mm Rotary Hammer SDS Plus

Code HR2811FT

Shank Type SDS Max
 Capacities max 28mm (concrete), 13mm (steel),
 32mm (wood)
 800W continuous rating input



Makita 32mm Rotary Hammer SDS Plus

Code HR3200C

Shank Type SDS Max
 Capacities max 32mm (concrete), 13mm (steel),
 32mm (wood)
 850W continuous rating input



Makita 32mm Rotary Hammer SDS Plus

Code HR3210FCT

Shank Type SDS Max
 Capacities max 32mm (concrete), 13mm (steel), 32mm (wood)
 850W continuous rating input



Power Cutters

The Makita 14 inch Power Cutter (model EK7301) is engineered to meet the demand for convenience and performance. It features faster starting, more power, and improved fuel economy. It has a 73cc engine, and a no load speed of 9,350rpm to take on the most demanding applications.



Brand	Code	Engine Displacement	Max power	No load speed	Circumferential Speed	Wheel Diameter	Max Cutting depth
Makita	EK7301WS	73cc	5.1hp	9350 rpm	80m/s	14"	122mm
Makita	EK8100	81cc	6.2hp	9350 rpm	80m/s	16"	147mm



Makita 355mm Power Cutter 4 Stroke

Code EK7651H

Environment-Friendly and Cost-Saving 4-Stroke Engine. Low-vibration system with damper springs to absorb vibration from engine to integrated front and rear handles.

Engine Displacement: 75.6cc
 Fuel Tank Capacity: 1.0L
 Cutting Disc: 355mm
 Cutting Depth: 97mm

Makita Power Cutter Guide Trolley

Code DT4000

This trolley will accommodate both Makita and Dolmar (and Wacker) power cutters from 12", 14" and 16" types. Thanks to the patented "Quick-Lock" mounting system, Makita Power Cutters (not included) can be mounted on the trolley in a matter of seconds without the use of tools.

Wheel axle may be displaced to left or right of travel direction, enabling close trimming at edges and obstacles. Trolley is equipped with an adjustable depth limiter for precise cuts to a desired depth.



Cut Off Saw

Makita Cut Off Saw

Code LW1400

D-shape handle for easy gripping. Spark diversion guard for operators safety. Adjustable guide plate 45° right and left at 3 locations. Quick release vise. Convenient storage space for wrench.

Blade Diameter: 355mm
 Cutting Capacity at 90 degrees: 127mm
 No Load Speed: 3800 rpm
 Continuous Rating Output: 2,200W



Wall Chaser

Makita 125mm Wall Chaser

Code SG1251J

Makita wall chaser offers the most efficient cutting of clean edged grooves for channels. Ergonomically designed handle for comfort. Conveniently located front cover efficiently prevents the dust from spreading, in every cutting depth. SJS system provides smooth & comfortable cutting by reducing start-up shock and protection from occasional blade jams.

Blade Diameter: 125mm
 Max Cutting Diameter: 6-30mm width
 Continuous Rating Output: 1,400W
 No Load Speed: 9,000rpm



Concrete Mixers

Electric Concrete Mixer 140L

Code MAN17035

Manners Concrete mixer is designed for the builder or tradesman requiring a reliable machine to work with and to mix all types of construction materials in complete confidence. The mixer can be assembled very easily and quickly and can be taken off the stand for transporting.

- Heavy Duty bowl with a capacity of 140 litres
- Bowl diameter is 590mm
- Direct drive motor turns at 23 RPM
- Motor (HP): 0.5
- Total weight 75kg
- Wheel Size 250mm x 75mm



Belle Mini Electric Concrete Mixer

Code M33BA

Concrete Mixer built for site durability, this is a quality, portable mixer for all small to medium building projects. The number one choice for mixers worldwide.

- Max drum capacity 130L
- Max mixing capacity 90L
- Electric engine 750w
- Enclosed Electric motor, sealed to IP 45
- Dimensions: (LxWxH mm – off stand) 597 x 890 x 1211
- Weight 55.5kg



Belle Mini Petrol Concrete Mixer

Code M54BPU

Built for site durability, this is a quality, portable mixer for all small to medium building projects. The number one choice for mixers worldwide.

- Max drum capacity 130L
- Max mixing capacity 90L
- Honda petrol engine
- Dimensions: (LxWxH mm – off stand) 597 x 890 x 1211
- Weight 61kg



Power Generators

3100W Electric Start Generator

Code GT3000ES

The functional Electric Start complements the industrial quality of the GT3000ES. With all the unique GT POWER features like industrial air cleaner & muffler system – for cleaner quieter operating, superior quality alternator & automatic voltage regulator (AVR) – for more stable power output and low oil alert with automatic engine shutdown. Ergonomic handles and heavy duty solid wheel kit with rubber tyres for portability make the GT3000ES ideal for using at the home, farm or construction site.

Output (Max) - 3100W
 Amps (Max) - 13.5
 Engine type - 4 Stroke OHV
 Fuel tank - 15L
 Run time - 9.5hrs
 Weight - 48kg



3800W Electric Start Generator

Code GT3600ES

The functional Electric Start complements the industrial quality of the GT3600ES. With all the unique GT POWER features like industrial air cleaner & muffler system – for cleaner quieter operating, superior quality alternator & automatic voltage regulator (AVR) – for more stable power output and low oil alert with automatic engine shutdown. With the capability of running a drop saw and all powertools the GT3600ES is ideal for the home workshop or garage.

Output (Max) - 3800W
 Amps (Max) - 16.5
 Engine type - 4 Stroke OHV
 Fuel tank - 15L
 Run time - 9.5hrs
 Weight - 50kg



5500W Electric Start Generator

Code GT5600ES

The heavy duty 25L fuel tank and the industrial quality of the GT5600ES will keep you in power all day. With all the unique GT POWER features like industrial air cleaner & muffler system – for cleaner quieter operating, superior quality alternator & automatic voltage regulator (AVR) – for more stable power output and low oil alert with automatic engine shutdown. With the capability of running multiple powertools or household items the GT5600ES is ideal for running the bach, farm shed or emergency back-up power.

Output (Max) - 5500W
 Amps (Max) - 23.9
 Engine type - 4 Stroke OHV
 Fuel tank - 25L
 Run time - 8.5hrs
 Weight - 81kg



7000W Electric Start Generator

Code GT7000ESQ

The large 25L fuel tank and industrial quality of the GT7000ES will keep you in power all day. This machine includes all the GT Power features like industrial air cleaner & muffler system, superior quality copper wound alternator & automatic voltage regulator (AVR) and low engine oil alert with automatic engine shutdown. Combine these benefits with the premium build quality of GT Power and you have a machine that provides sterling service for a lifetime! With the capability of running multiple powertools, lights and industrial equipment, the GT7000ES is ideal for running the bach, farm shed or emergency back-up power. Featuring an inbuilt RCD and twin 15A outlets this machine is ready to tackle the toughest task including powering a welding machine up to 150A.

Output (Max) - 7000W
 Amps (Max) - 27
 Engine type - 4 Stroke OHV
 Fuel tank - 25L
 Run time - 13hrs
 Weight - 88kg



10000W Electric Start Generator

Code GT10000ESQ

The large 25L fuel tank and the industrial quality of the GT10000ESQ will keep you in power all day. With all the unique GT POWER features like the patented Tomahawk Alternator, industrial air cleaner & muffler system, automatic voltage regulator (AVR) and low oil alert, this state of the art generator empowers you to tackle any task! This machine is the Big Boy in the range and packs a serious punch - being able to power a small house, workshop or a work site. Also the ideal generator for back-up power in natural disasters.

Output (Max) - 9000W
 Amps (Max) - 35
 Engine type - 4 Stroke OHV
 Fuel tank - 25L
 Run time - 8hrs
 Weight - 94kg



Waterblasters

Powershot Petrol Waterblaster 3000psi

Code PS3395

Kohler SH265 SH Series Engine with low oil protection. 3300psi 9.5L/min cleaning power! AAA Cougar® Series triplex pump. Heavy gauge professional chassis. 10" Pneumatic tyres. 5/16" 8m High Pressure morflex hose. Pro-style spray gun & wand with QC nozzles. Powerboost technology which provides higher pressure at the nozzle cleaning surface. Downstream detergent injection system for convenient use of detergents. Made in USA.



Powershot Petrol Waterblaster 3000psi

Code PS3000HD

Powershot 3000psi, 11L/min Waterblaster. Premier series Honda GX200 OHV industrial engine with 3 year commercial warranty. Industrial cat pump with brass pump head. Heavy gauge aircraft grade aluminium frame with 10" pneumatic wheels for super portability. Dial-n-Wash handgun to adjust pressure from 1000 – 3000psi on the go. 15m x 3/8" super duty abrasion resistant steel braided 'monster hose'. 5 x Quick Connect nozzles including detergent nozzle. Convenient on board accessory storage.



Powershot Petrol Waterblaster 4200psi

Code PS4200HD

Powershot 4200psi, 16L/min Waterblaster. Honda GX390 OHV Industrial Engine. 15m x 3/8" super duty abrasion resistant steel braided Monster Hose. 5 x Quick connect nozzles including detergent nozzle. Heavy-duty stainless steel gauge frame with 13" pneumatic wheels for superb portability.





Core Drills

Shibuya Core Drill 180mm

Code HH1531

Hand or rig mount Core Drill – can be used with TSH-163 angle stand.
 Compact three-speed gear box with high, medium, and low speed. Weights only 6.5 Kg (15 lbs). D-style handle for ergonomic control. Multi-position front handle. Built-in on/off switch with low voltage drop-out and motor overload protection. Portable Residual Current Device (P.R.C.D.) automatically shuts off electricity in the event of electric leakage. Tool kit including a wrench. Optional spindle adaptors for each countries' circumstances.

Rated Input: 1,500 W
 Voltage: AC 110-120 V / AC 220-240 V 50/60 Hz
 Spindle Revolutions at No Load: 800/2000/4150 rpm
 Spindle Revolutions at Rated Load: 560/1400/2900 rpm
 Recommended Core Bit Diameter in Rig Mounted Mode: 14.5 to 180 mm (1/2" to 7")
 Spindle Thread: G1/2" (BSPP1/2")
 Weight: 6.5 kg (15 lbs)

Shibuya Stand

Code TSH-163

Stand Column: 1000 mm (39") with 748 mm (29") stroke. 50 x 50 mm (2" x 2") square column. Right and left hand feed handle positions.
 2 way mounting method: – 30 mm Bolt-on Spacer – Clamp Ring Spacer.
 Tool kit including wrenches, allen keys, and core removal wedge lasso.
 Angle stand with roller carriage



Shibuya Drill 250mm

Code R1721

Use with TS-252A angle stand. Ideal machine for middle size jobs. Multi-position water swivel inlet for convenience. Right and left hand feed handle positions. Built-in on/off switch with low voltage drop-out and motor overload protection. Portable Residual Current Device (P.R.C.D.) automatically shuts off electricity in the event of electric leakage. (220-240 V only). Two motor available: R1721 (Normal)/ R1722 (Small diameter). Includes water collector ring. Normal Stand Column: 800 mm (31") with 488 mm (19") stroke. Long Column: 1000 mm (39") with 688 mm (27") stroke. Angle Drill AB52 Column: 1000 mm (39") with 688 mm (27") stroke. 50 x 50 mm (2" x 2") square column. Tool kit including wrenches and allen keys.



Shibuya Drill 400mm

Code R2231

Use with TS-403 angle stand

Ideal machine which covers all range up to 400 mm core drilling jobs. Multi-position water swivel inlet for convenience. Right and left hand feed handle positions. Built-in on/off switch with and motor overload protection. Portable Residual Current Device (P.R.C.D.) automatically shuts off electricity in the event of electric leakage. (220-240V only). Normal Stand Column: 1000mm (39") with 618 mm (24") stroke. 60 x 60 mm (2-3/8" x 2-3/8") square column. Tool kit including wrenches and allen keys.

Rated Input: 3,100 W (110-120V) / 2,800 W (220-240V)

Voltage: AC 110-120 V / AC 220-240 V 50/60 Hz

Speed: 3

Spindle Revolutions at No Load: 300 / 800 / 1400 rpm

Spindle Revolutions at Rated Load: 210 / 580 / 1000 rpm

Recommended Core Bit Diameter: 25 – 400 mm

Spindle Thread: UNC 1 -1/4" / A-Rod

Weight: 13.6 kg



Shibuya Drill 600mm

Code R2531

Use with TS-603 stand.
 Ideal machine for large diameter core drilling jobs. Multi-position water swivel inlet for convenience.
 Right and left hand feed handle positions. Built-in on/off switch with and motor overload protection.
 Portable Residual Current Device (P.R.C.D.) automatically shuts off electricity in the event of electric leakage. (220-240 V only).
 Normal Stand Column: 1100mm (43") with 625 mm (24") stroke.
 73 x 73 mm (2-7/8" x 2-7/8") square column. Positive carriage lock. Tool kit including wrenches and allen keys.

Rated Input: 3,100 W (110-120 V) / 2,800 W (220-240 V)
 Voltage: AC 110-120 V / AC 220-240 V 50/60 Hz
 Speed: 3
 Spindle Revolutions at No Load: 150 / 300 / 600 rpm
 Spindle Revolutions at Rated Load: 105 / 210 / 420 rpm
 Recommended Core Bit Diameter: 110 – 600 mm (4" – 24")
 Spindle Thread: UNC 1 -1/4" / A-Rod
 Weight: 19.2 kg



(Drill shown on TS-603 stand)

Shibuya Automatic Feed Systems

Feeds the drill motor automatically. Detect the load of the drill motor and automatically adjust the feeding speed.
 Mountable on both right and left side of the carriage block.
 Automatically shuts off when the core bit penetrates the working material.

Brand	Code	Description
Shibuya	SAF-403	Suits TS403 stand
Shibuya	SAFA-252	Adaptor plate to suit TS252
Shibuya	SAFA-403AD	Auto feed adapter suit TS403



Shibuya Vacuum Pump

Code S-VPT

Very strong suction with SHIBUYA vacuum pads.
 2 litres reserve tank equipped.

220-240V 1A 50/60Hz
 Maximum vacuum degree: -0.09 MPa
 Pumping Speed: 40 – 45 L/min
 Size: W202 x L308 x H317 mm
 Weight: 13.1 kg



Core Drill Accessories

Vacuum Holding Down Systems

Without using anchors, it enables mounting of core drill machines to concrete surface using a vacuum pump.

Brand	Code	Description
Shibuya	S-VP-STEP	Step width pad to suit TS163 stand
Shibuya	S-VPS	Shibuya vac pad S suit THS163
Shibuya	S-VPL	Shibuya vac pad L suit 252/403 stand
Shibuya	S-VPXL	Shibuya vac pad XL suit big holes
Shibuya	S-TVPS	Shibuya twin vac pad S for pipes
Shibuya	S-TVPL	Shibuya twin vac pad L for pipes



Holding Down Systems

Brand	Code	Description
Totalsite	M12ANCHOR+ROD	M12 Holding Down Assembly with Rawishield
Totalsite	M12KNOCKINA	M12 Knock-in Anchor
Totalsite	M12SETT	M12 Setting Tool



Core Removal Systems

Brand	Code	Description
Totalsite	WEA/T/CPSM	Core Pusher - screws into the back of the core drill to force difficult ones out
Totalsite	WEA/S/CPLL	Core Puller - for extracting jammed core drills



BSP Extension Rods

Brand	Code	Size
Totalsite	BSPEXTN100BSP	100mm
Totalsite	BSPEXTN200	200mm
Totalsite	BSPEXTN300	300mm
Totalsite	BSPEXTN400	400mm
Totalsite	BSPEXTN500	500mm



UNC Extension Rods

Brand	Code	Size
Totalsite	UNCEXTN100MM	100mm
Totalsite	UNCEXTN200MM	200mm
Totalsite	UNCEXTN300MM	300mm
Totalsite	UNCEXTN400MM	400mm
Totalsite	UNCEXTN500MM	500mm



Adaptors

Brand	Code	Description
Totalsite	R1/2M-R1/2M	1/2" BSP/M to 1/2" BSP/M
Totalsite	R1/2F-R1/2F	1/2" BSP/F to 1/2" BSP/F
Totalsite	R1/2M-11/4M	1/2" BSP/M TO 1 1/4" UNC/M
Totalsite	R1/2F-11/4F	1 1/3" UNC/F TO 1/2" BSP/F
Totalsite	R1/2F-11/4M	1 1/4" UNC/M TO 1/2" BSP/F



Laser Levels

Veritech Rotary Laser Level

Code LXR

This laser is recommended for Heavy Duty Civil and Building applications. Manufactured with this in mind this laser has been designed to withstand and remain accurate in harsh conditions.

- Accuracy: +/- 3mm over 30 metres (+/-20 arc seconds)
- Self Levelling: Yes
- Operating Diameter: 300m diameter
- Rotation Speed: 0, 60, 300 & 600rpm
- Continuous Operating: 40hrs approx
- Battery Type: 4x 1.5V batteries (included)
- Weight: 2kg
- Weather Protection: IP54



Pro Shot Alpha Laser Level

Code PS-ALPHA

Alpha laser, R9 receiver with clamp, heavy duty flat aluminium tripod, alkaline batteries, NZ dated calibration sticker, shockwatch, NZ test calibration certificate – laminated, user manual and hard carry case.

- Accuracy: +/- 1.5mm at 30m (10 arc seconds)
- Self Levelling: Yes
- Operating Diameter: 610m
- Rotation Speed: 600 & 1200rpm
- Battery Life: 115 hours
- Battery Type: 4x C alkaline
- Weight: 1.92kg incl. batteries
- Weather Protection: IP56



Pro Shot AS-2 Grade Laser

Code PS-AS2

AS2 laser, R9 receiver with clamp, heavy duty flat aluminium tripod, alkaline batteries, NZ dated calibration sticker, shockwatch, NZ test calibration certificate – laminated, user manual and hard carry case.

- Accuracy: +/- 2mm at 30m (14 arc seconds)
- Self Levelling: Yes
- Grade Range: Single grade 0-25%
- Grade Increments: 0.01%
- Operating Diameter: 610m
- Rotation Speed: 600rpm
- Battery Type: 4x C Alkaline (optional rechargeable available)
- Battery Life: 115 hours
- Weight: 2.01kg incl. batteries
- Weather Protection: IP56



Diesel Heaters

Diesel Heater RPH75R

Code RPH75R

Improve productivity and reduce equipment failure by ensuring your employees, buildings and equipment are kept warm and dry this winter. Remington Diesel Heaters, the only power heaters on the market to be Optimised for NZ Fuel, also give you a healthier work environment, up to 50% reduction in noise and reduced operating costs. Intensively test, modified, re-engineered and optimised for the best reliability, performance and efficiency, Remington Power heaters are a smart choice this winter.

- 70K BTU Silent Drive Radiant Heater
- Ultra Portable – Only 13kg!
- 21kW – 162m² heating
- 12 litre tank for up to 6 hrs heating
- Built in thermostat
- Multi fuel capable
- Only 71dBA @ 1m



Diesel Heater RPH700KFA

Code RPH700KFA

Remington Diesel Heaters, the only power heaters on the market to be Optimised for NZ Fuel, also give you a healthier work environment, up to 50% reduction in noise and reduced operating costs. Intensively test, modified, re-engineered and optimised for the best reliability, performance and efficiency, Remington Power heaters are a smart choice this winter.

- 70,000 Btu Radiant Heater
- Ultra Portable – Only 13kg!
- 21kW – 158m² heating
- 13 litre tank for up to 9 hrs heating
- Built in thermostat
- Multi fuel capable
- 92dBA @ 1m



Diesel Heater RPH1250KFA

Code RPH1250KFA

Improve productivity and reduce equipment failure by ensuring your employees, buildings and equipment are kept warm and dry this winter.

Remington Diesel Heaters, the only power heaters on the market to be Optimised for NZ Fuel, also give you a healthier work environment, up to 50% reduction in noise and reduced operating costs.

Intensively test, modified, re-engineered and optimised for the best reliability, performance and efficiency, Remington Power heaters are a smart choice this winter.

- 125,000 Btu Forced Air Heater
- Ultra Portable – 30kg with solid wheels
- 37kW – 288m² heating
- 24 litre tank for up to 10 hrs heating
- Built in thermostat
- Multi fuel capable
- 92dBA @ 1m



Diesel Heater RPH2200DFV

Code RPH2200DFV

Improve productivity and reduce equipment failure by ensuring your employees, buildings and equipment are kept warm and dry this winter.

Remington Diesel Heaters, the only power heaters on the market to be Optimised for NZ Fuel, also give you a healthier work environment, up to 50% reduction in noise and reduced operating costs.

Intensively test, modified, re-engineered and optimised for the best reliability, performance and efficiency, Remington Power heaters are a smart choice this winter.

- 220,000 Btu Dual Fusion Radiant Heater
- Ultra Portable – 31kg with solid wheels
- 65kW – 511m² heating
- 49 litre tank for up to 10 hrs heating
- Built in thermostat
- Multi fuel capable
- 82dBA @ 1m



Vacuums

Starmix Drywall Dust Extractor

Code NSGADL1435EHP

The Starmix NSG uClean Dust Extractor has been specially developed for vacuuming paint and plaster dust away directly from the Intex Giraffe Sander and other paint and plaster sanding machines. These machines are perfectly suited for continual, daily use in the tough, professional conditions on the building site by the trade or in industrial applications. HEPA filters are available for use in hazardous dust applications, eg: lead-based paint removal.

- Volume flow 69 liters/second
- Vacuum pressure 259mbar
- 1400 watt motor
- 35 litre canister
- Stepless speed control
- Main Filter – 7200 cm² polyester coated
- Pre-filter – 4000 cm² polyester – extend life of main filter
- Both filters can be washed to extend life
- Bag-free use in non-hazardous applications
- Designed for wet & dry use
- Power tool socket with automatic stop/start
- Electronic after-running feature to clean out hose
- Overflow protection when vacuuming water
- Storage space for all standard accessories
- 30 Month Warranty



Starmix eSwift Dust Extractor 32L

Code NTSA1232EHP

Starmix Dust Extractor NTS eSwift Series 32L 1200W ANTS1232 Description Starmix NTS eSwift series vacuum has been designed for vacuuming and cleaning up of general and rubbish on a building site. Perfectly suited for continual daily use in tough, professional conditions on building sites or industrial applications. Wet/Dry. Suitable for small amount of plaster dust.

- Volume flow 32 liters/second
- Vacuum pressure 259mbar
- 1200 watt motor
- 35 litre canister
- Designed for wet & dry use
- HEPA filters available
- Carry handle with cable and hose coil
- Overflow protection
- Power tool socket
- Soft start control
- Electronic after-running feature



Starmix eSwift Dust Extractor 20L

Code NTS1220EHP

The Starmix NSG eSwift Dust Extractor has been specially developed for vacuuming paint and plaster dust away directly from the Intex Giraffe Sander and other paint and plaster sanding machines.

These machines are perfectly suited for continual, daily use in the tough, professional conditions on the building site by the trade or in industrial applications. HEPA filters are available for use in hazardous dust applications, eg: asbestos and lead-based paint removal.

- Wet & dry manual pulse filter cleaning
- Carry handle with cable and hose coil
- 1200W motor
- 20L plastic canister
- Power tool socket switch
- Soft start control
- Water level detection
- Accessory storage kit
- Washable polyester pre-filter



Starmix iPulse Series

Code ISPIARDL1635EHB

The NEW Starmix iPulse-Series Dust Extractor has been specially developed for hard, heavy-duty continuous use in industry, in the workshop and on the construction site. The patented, intelligent, permanent filter cleaning system, iPulse sets this machine apart in effective performance.

For the toughest heavy-duty continuous use in industry, in the workshop and on the construction site.

- Auto electromagnetic pulse filter cleaning
- 1600W motor
- 35L double walled plastic container
- Appliance socket with automatic ON/OFF switch
- Step-less Speed control
- Volume flow display
- Gentle start control
- Electronic after-running feature
- Water detection with sensor switch-off
- Antistatic prepared
- Carrying handle with retractable cable hook and hose take-up
- Accessory department



Crusader 220L Dry/Slurry Vacuum

Code M1050-30

The Crusader 30 Gallon Concrete Vacuum is great for recovering concrete slurry. The vacuum has a sturdy powder coated steel cart with 10" pneumatic wheels for rolling across rough terrain on jobsites.

This vacuum comes equipped with a filter bag for wet slurry recovery but can also be used for dry recovery with the proper filters (4049 coated bag, 4031 filter protector).

The heavy duty T-Bar drain plug on the 3' hose drains liquids out the back of the machine efficiently.

Other features include a powerful 2 hp, 105" water lift motor and 4" heavy duty extra wide swivel casters. It also comes with a 1 1/2" 15' crushproof hose.

- Polyethylene Tank that won't dent or corrode
- 10" Heavy Duty Pneumatic Wheels roll across uneven surfaces easily
- 4" Heavy Duty Extra Wide Swivel Casters
- Powerful 2 hp., 105" water lift motor
- Chrome Steel vacuum head assembly
- Stainless Steel Shaft with a Vortex style Urethane Rubber Impeller
- 1 1/2" 15' Crushproof Hose
- Switch guard over pump switch
- Heavy Duty 1/2 Hp. Pump
- Heavy Duty Powder Coated Steel Cart
- 25' Trash Pump Hose
- Pumps 15 - 50 GPM at 5 Ft. - 34 Ft. Head
- Thermal protected, oil lubricated pump
- Shielded ball bearings on the pump



Wheelbarrows

The Contractor Wheelbarrow

Code 1350022

The Greens Contractor Wheelbarrow is a legend in the trade!

Trusted and relied upon by tradesmen – proven for over 35 years. The Contractor has withstood the harshest conditions and earned the respect of thousands.

- Bolt Free Seamless Tray
- No Rust Frame
- Tough Steel Construction
- Superior Balance and Control
- 72L capacity
- 22kg



The Loadmaster Wheelbarrow

Code 1370036

The big performer!

Load it to the hilt... push it to the limit! The Loadmaster makes light work of shifting big loads fast and brings a new dimension to the worksite. Out performs others... day in, day out.

- Easy Pushing
- Bigger load – Lighter lift
- No Rust Frame
- Superior Balance and Control
- 110L capacity
- 29kg



The Ezy-Pour Wheelbarrow

Code 1390043

Tough when it counts!

Built for the rigours of the work site – equally at home in the back yard. Years of use have cemented the Ezipour barrow's reputation. Designed to carry – built to pour.

- Bolt Free Tray
- Superior Pouring
- No Rust Frame
- Heavy Duty Construction
- 72L capacity
- 17.5kg



Sprayers

Spraysmart 16L Industrial Backpack Sprayer

Code HD400

16 litre industrial backpack sprayer. With chemical resistant viton seals it can handle oil based release agents and is a must for the precast yard. Great for curing agents and surface retarders.



Ox Pro Industrial Concrete Sprayer 13.2L

Code OX-P040713

Stainless steel, heavy-duty pump, spray wand and tank. Flexible heavy-duty, chemical-resistant hose. Superior lock-on trigger assembly. Ergonomic pump handle. Wide-mouth opening for easy filling and cleaning. Holster for wand and nozzle storage.

- Stainless Steel Heavy Duty Pump
- Stainless Steel Spray Wand
- Stainless Steel Tank
- Flexible Heavy Duty Chemical Resistant Hose
- Superior Lock-on Trigger Assembly
- Ergonomic Pump Handle
- Genuine OXSeals Equipped
- Wide Mouth Opening for Easy Filling & Cleaning
- Holster for Wand & Nozzle Storage



Bricklayers Equipment

Arbortech Hand Held Brick Saw

Code AS175

The Allsaw AS175 is ideal for Trade Professionals and DIY enthusiasts, there is a number of specialised blade options for specialised trade applications. The clever ergonomic design improves balance and control, whilst preventing dangerous and deadly kickbacks. Engineered to significantly improve safety and efficiency when cutting brick walls, mortar and more.



- Powerful 1400W motor
- Trigger switch
- Adjustable belt drive
- Ergonomic soft grip handle
- Tungsten Carbide teeth blades

Saint Gobain Brick Saw

Code 70184693678 (CM42)

This portable brick saw is ideal for safe and easy cutting of bricks, pavers, ceramic tiles and other similar smaller building materials. The CM42 has a direct drive motor. Its all steel frame makes it extremely rigid and has foldable legs for easy transportation and storage.



- Power: 2.2kW
- Fuse/Generator: 16A/6kVA
- Max Blade x Bore: 400 x 25.4mm
- Max Cutting Depth at 90 degrees: 135mm
- Max Cutting Length: 600mm

Plus we supply Brick Trowels, Brick Profile Brackets, Brick Ties, Bricklock, Bricktor, Mortar Mixers, Chemicals and more!





DIAMOND CUTTING & GRINDING

Diamond Blades

General Purpose Blades

Kea General Purpose Blades - Trade

Kea Tool General Purpose Diamond Cutting blades are premium quality blades specifically designed to handle the tough conditions of New Zealand, making them an ideal choice for professionals who work with reinforced concrete and granite. Available exclusively from Totalsite Supplies, you can expect reliable, high quality performance every time.

Brand	Code	Diameter (mm)
Kea	TSSBLADE125	125
Kea	TSSBLADE230	230



Tusk General Purpose Blades - Trade

Best all round blade on the market designed to cut! Great for expansions, asphalt, general concrete, schist, cobblestones, pavers, bricks. Long life, free cutting.

Brand	Code	Diameter (mm)
Tusk	TMIC350	350
Tusk	TMIC400	400



Xceeder Super Combi - Professional

Designed to efficiently cut the wide variety of common concrete, asphalt, masonry materials encountered by roading and general construction contractors

Brand	Code	Diameter (mm)
Xceeder	XSC-360	360
Xceeder	XSC-410	410



Brick Saw Blades

XXR General Purpose/Silent Blades

XXR have been developed as fast cutting reinforced concrete blades for single phase electric hand held saws. They also work well on brick saws and other saws with 2 to 3kw motors . The unique patterned segments require less torque to cut hard materials fast. This protects the machine from bogging down and overloading, it also encourages straighter cuts. It is recommended to wet cut concrete with steel reinforcing, however XXR can successfully be used dry or wet on many other common masonry materials.

Brand	Code	Description
XXR	XXR350LP	355mm Diameter, 12mm tall segments
XXR	XXR400LP	405mm Diameter, 12mm tall segments

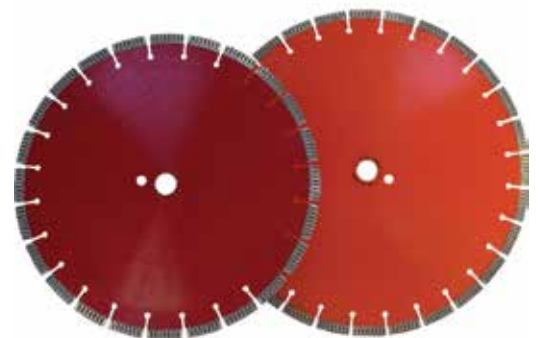

Xceeder Silencio Professional Blades

Fast cutting of clinkers and other hard clay bricks and pavers. These robust blades offer rapid continuous cuts. Suitable for: Brick and block saws, dedicated silent cutting reduced blades for bricks and pavers

Code	Description
XSHC-350	350mm Diameter 10mm segments

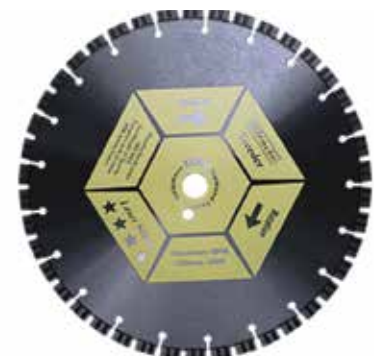

Multistar Universal/Hard Blades

General purpose economy blade for a wide variety of construction materials without steel reinforcing. Bricks/pavers, Clay pipes, Terrazzo, Concrete (regular to soft), Soft bluestone (Basalt), Cement sheet, Concrete roof tile, Limestone, Asphalt.

Brand	Code	Description
Multistar	ML-350GR	350mm Green Diamond Blade / Medium Brick
Multistar	ML-350BK	350mm Black Diamond Blade / Soft Brick

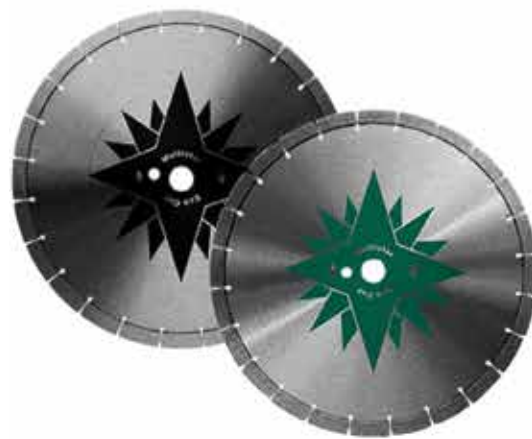

Concrete Blades

Ultimate UC10 Cyclone Concrete Blades

Blade with 10mm segment height. Featuring tear drop gullet design, cooling holes, reinforced centre flange. Applications include: in-situ concrete (including reinforced), concrete products, natural stone, building materials. Ideal 'civils' blade.

Brand	Code	Diameter (inches)
Ox	OX-UC10-4	4
Ox	OX-UC10-4.5	4 1/2
Ox	OX-UC10-5	5
Ox	OX-UC10-9	9
Ox	OX-UC10-14	14
Ox	OX-UC10-16	16



Trade TC10 Concrete Blades

This general purpose blade with a 10mm segment height. All round performance. Applications include: building products, general purpose, kerbs and slabs, concrete pavers and blocks, roof tiles.

Brand	Code	Diameter (inches)
Ox	OX-TC10-4	4
Ox	OX-TC10-4.5	4 1/2
Ox	OX-TC10-5	5
Ox	OX-TC10-9	9



Asphalt Blades

Asphalt Hand Saw Blades

Very long life in asphalt and abrasive materials. Suitable to used for concrete blocks/pavers (soft), Green concrete (set 18 to 36 hrs), Limestone, Asphalt, Sandstone.

Brand	Code	Diameter (mm)
Xceeder	XSB-350	350
Xceeder	XSB-400	410



Tile Blades

XFactor Pro Blade

Wet or dry cutting. Suits all angle grinders and saws with 22.2, 20 and 16mm shafts. Professional rapid clean cutting of all tiles including porcelain and granite.

Brand	Code	Diameter (mm)
XFactor	XFT-100PT	100
XFactor	XFT-115PT	115
XFactor	XFT-125PT	125



Turbo Tile Blade

Fast, smooth wet or dry cutting of marble, porcelain and other hard products.

Brand	Code	Diameter (mm)
Tusk	TTT105	105
Tusk	TTT115	115
Tusk	TTT125	125



Continuous Tile Blades

High-end professional blade. Very smooth cutting of ceramic, porcelain, marble and granite.

Brand	Code	Diameter (mm)
Tusk	TCB105	105
Tusk	TCB115	115
Tusk	TCB125	125
Tusk	TCB180	180
Tusk	TCB200	200
Tusk	TCB230	230



Green Concrete Blade

355mm Green Concrete Blade Hand Saw/Small Road Saw.

Brand	Code	Diameter (mm)
VectorTech	VTP-355GRN-HT	355mm



Tuck Pointing Blades

PMR Tuck Pointing Blades

High quality 6mm wide segment blade. Applications include: mortar raking and abrasive materials.

Brand	Code	Diameter (inches)
Ox	OX-PMR-4.5	4 1/2
Ox	OX-PMR-5	5
Ox	OX-PMR-7	7



Wide Blades

Xceeder - XPL Wide Blades

For fast 10mm wide cuts in general and harder building materials. Suitable for power tools.

Brand	Code	Diameter (mm)
Xceeder	XPL-100/10	100
Xceeder	XPL-125/10	125
Xceeder	XPL-230/10	230



Concrete Chasing Blades

Xceeder Pro - XPCC Concrete Chasing Blades

Rapid cuts and long life in designated materials. Suitable for power tools.

Brand	Code	Diameter (mm)
Xceeder	XPCC-100V	100
Xceeder	XPCC-180V	180



Panel Cutter Blade

Code PC150X25

Also known as sandwich panel, cold room panel, freezer panel and thermal panel. The panel cutter produces a smooth clean cut for all types of EPS panels. The double bevelled edges fold the edge as you cut to improve panel joints. 150mm diameter. 25mm bore.



Grinding Cups

CWX – Red Professional Quality Grinding Disc

Code CWX-180

12 segments for aggressive surface grinding at a lower initial cost. Available in 2 types : RED for harder materials, BLACK for softer and more abrasive materials. Fast segment, clean sweep marks, medium aggression, good general purpose. Middle bond 30/40. Suitable for angle grinders.

Size 180mm
Cutting speed: Fast
Grit: Coarse



CWX – Black Professional Quality Grinding Disc

Code CWX-180B

12 segments for aggressive surface grinding at a lower initial cost. Available in 2 types : RED for harder materials, BLACK for softer and more abrasive materials. Suitable for angle grinders.

Size 180mm
Cutting speed: Fast
Grit: Coarse



MAX-S Professional Quality Grinding Cup

Outstanding grinding performance and long life. Very popular G.P. cup wheels. Suitable for angle grinders.

Brand	Code	Size	Cutting speed	Grit
Totalsite	CWP-100S	100mm	Good	Coarse
Totalsite	CWP-125S	125mm	Good	Coarse
Totalsite	CWP-180S	180mm	Good	Coarse



PRO DR – Professional Quality Grinding Disc

Double row design ideal for trip hazard removal and a less aggressive finish. Long life and good speed. Suitable for angle grinders.

Brand	Code	Size	Cutting speed	Grit
Totalsite	CWP-100DR	100mm	Good	Coarse
Totalsite	CWP-125DR	125mm	Good	Coarse
Totalsite	CWP-180DR	180mm	Good	Coarse



TSS Double Row Grinding Cups M14

Brand	Code	Size
Totalsite	TSSCUPDR3040105	40/60 Grit, 105mm
Totalsite	TSSCUPDR3040125	40/60 Grit, 125mm
Totalsite	TSSCUPDR304080	40/60 Grit, 180mm



TSS Turbo Grinding Cups M14

Brand	Code	Size
Totalsite	TSSCUP3040	30/40 Grit, 125mm
Totalsite	TSSTURBOCUP22.23	30/40 Grit, 125mm
Totalsite	TSSCUP3040180	30/40 Grit, 180mm
Totalsite	TSSCUP4060	40/60 Grit, 125mm
Totalsite	TSSCUP4060180	40/60 Grit, 180mm



L Turbo Cup Grinding Wheel

Fast and aggressive for quick removal. Designed for angle grinder to get close to edges with minimal sweep marks. "L" shapes segments engineered for aggressive removal of concrete surfaces and other hard construction products.

Brand	Code	Size
Totalsite	GLT105	105 x 8 x 22.23/16 Fast Bond 30/40
Totalsite	GLT125	125 x 8 x 22.23 Fast Bond 30/40
Totalsite	GLT180	180 x 8 x 22.23 Fast Bond 30/40



Stripper Trade Quality Prep Disc

For fast stripping of paints, glues and epoxies. Leaves the surface lightly scored for keying if new coating. Suitable for angle grinders.

Brand	Code	Size	Cutting speed	Grit
Totalsite	CWP-100/4	100mm	Fast	Coarse
Totalsite	CWP-125/4	125mm	Fast	Coarse
Totalsite	CWP-180/5	180mm	Fast	Coarse



PCD Cup Grinding Wheel

PCDs are for scraping coatings from the floor or walls. A great system for smooth surfaces.

Brand	Code	Size
Totalsite	GPCD125	125 x 6ST x 22.23
Totalsite	GPCD180	180 x 6T x 22.23



Arrow Professional Quality Prep Discs

Popular prep discs ideal for peeling off thick coatings of rubberised glues etc. Very fast removal of soft to medium hard concrete. Suitable for angle grinders.

Brand	Code	Size	Cutting speed	Grit
Totalsite	CWP-100/5ASC	100mm	Very Fast	Ultra Coarse
Totalsite	CWP-125/6ASC	125mm	Very Fast	Ultra Coarse
Totalsite	CWP-180/6ASC	180mm	Very Fast	Ultra Coarse



Deco Discs – T Medium Professional Quality

Medium finishing disc to remove heavy scratches fast. Leave a smooth honed finish with some grip. Suitable for angle grinders.

Brand	Code	Size	Cutting speed	Grit
Totalsite	CWP-T100M	100mm	Fast	Medium
Totalsite	CWP-T125M	125mm	Fast	Medium
Totalsite	CWP-T180M	180mm	Fast	Medium

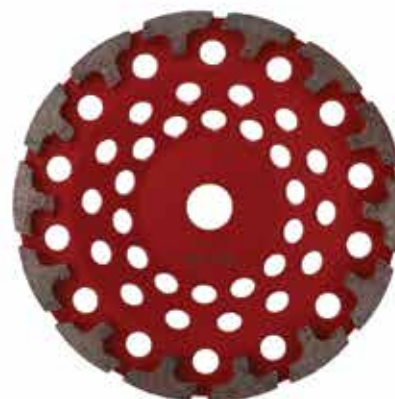

Deco Discs – T Fine Professional Quality

Fine finishing to remove scratches bringing aggregate colours to life prior to polishing or clear coating. Suitable for angle grinders.

Brand	Code	Size	Cutting speed	Grit
Totalsite	CWP-T100F	100mm	Good	Fine
Totalsite	CWP-T125F	125mm	Good	Fine
Totalsite	CWP-T180F	180mm	Good	Fine



Deco Discs – T Super Fine Professional Quality

Super fine finish, adds depth to aggregate. 300 grit polished finish. Suitable for angle grinders.

Brand	Code	Size	Cutting speed	Grit
Totalsite	CWP-T100SF	100mm	Good	Super Fine
Totalsite	CWP-T125SF	125mm	Good	Super Fine
Totalsite	CWP-T180SF	180mm	Good	Super Fine



Polishing Pads

Dry Polishing Pads – Honeycomb. Premium quality diamond polishing pads for use on angle grinder to polish hard materials. Can be used wet.

Backing Pads available also in sizes M14 100mm & M14 125mm.

Brand	Code	Size
Totalsite	TPPH100 50	100mm 50#
Totalsite	TPPH100 100	100mm 100#
Totalsite	TPPH100 200	100mm 200#
Totalsite	TPPH100 400	100mm 400#
Totalsite	TPPH125 50	125mm 50#
Totalsite	TPPH125 100	125mm 100#
Totalsite	TPPH125 200	125mm 200#
Totalsite	TPPH125 400	125mm 400#
Totalsite	TPPH125 800	125mm 800#
Totalsite	TPPH125 1500	125mm 1500#
Totalsite	TPPH125 3000	125mm 3000#

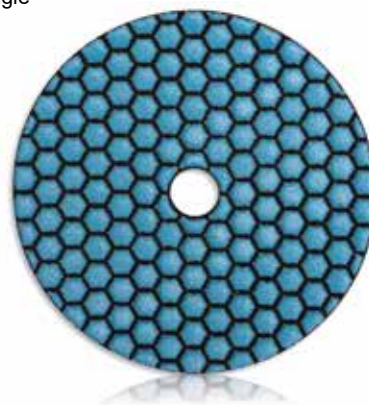

Diamond Hand Pad

Sizes available:

85 x 55 x 50#
 85 x 55 x 100#
 85 x 55 x 200#
 85 x 55 x 400#

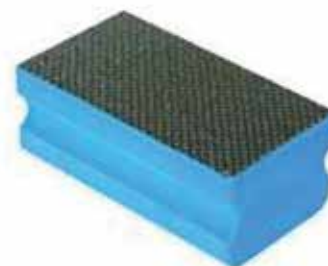

Masonry Abrasive Cup

Tapered cup wheels are designed for grinding concrete floors, surface finishing and concrete construction work.

Brand	Code	Size	RPM
Totalsite	CR24R Masonry	110/95 x 50 x M14	8500 max
Totalsite	CR24 Masonry	130/95 x 55 x M14	6880 max



Zec Plastic Disc for Masonry

Resin bonded silicon carbide abrasive on heavy plastic backing for removal of surface coatings, smoothing of rough concrete and edge of fibre cement board prior to joining. No back up pad needed.

Brand	Code	Size	Grit
Totalsite	1014016	115 x 22	16 grit
Totalsite	1015016	178 x 22	16 grit
Totalsite	1014024	115 x 22	24 grit



Masonry Drill Bits

SDS Plus Zentro 4 Cutter with Carbide Tip (Metric)

The Alpha ZENTRO Masonry range boasts dynamic drilling ability with secondary cutters protecting the drill bit in the event of reinforcement collision. The one-piece, solid carbide tip and patented reinforcing chamfering ensure low vibration and optimum drilling performance when drilling into reinforcing steel. Thanks to optimum 4 x 90° symmetry, all four carbide cutting edges function evenly and do not seize up on hitting reinforcing steel. Shank diameter 10mm.

Brand	Code	Description	Diameter mm	Overall Length	Flute Length
Alpha	SPZ050110	Alpha SDS + Zentro Masonry Drill 5.0x110	5	110	50
Alpha	SPZ050160	Alpha SDS + Zentro Masonry Drill 5.0x160	5	160	100
Alpha	SPZ055110	Alpha SDS + Zentro Masonry Drill 5.5x110	5.5	110	50
Alpha	SPZ055160	Alpha SDS + Zentro Masonry Drill 5.5x160	5.5	160	100
Alpha	SPZ060110	Alpha SDS + Zentro Masonry Drill 6.0x110	6	110	50
Alpha	SPZ060160	Alpha SDS + Zentro Masonry Drill 6.0x160	6	160	100
Alpha	SPZ060210	Alpha SDS + Zentro Masonry Drill 6.0x210	6	210	150
Alpha	SPZ065110	Alpha SDS + Zentro Masonry Drill 6.5x110	6.5	110	50
Alpha	SPZ065160	Alpha SDS + Zentro Masonry Drill 6.5x160	6.5	160	100
Alpha	SPZ065210	Alpha SDS + Zentro Masonry Drill 6.5x210	6.5	210	150
Alpha	SPZ080160	Alpha SDS + Zentro Masonry Drill 8.0x160	8	160	100
Alpha	SPZ080210	Alpha SDS + Zentro Masonry Drill 8.0x210	8	210	150
Alpha	SPZ100160	Alpha SDS + Zentro Masonry Drill 10x160	10	160	100
Alpha	SPZ100210	Alpha SDS + Zentro Masonry Drill 10x210	10	210	150
Alpha	SPZ100260	Alpha SDS + Zentro Masonry Drill 10x260	10	260	200
Alpha	SPZ120160	Alpha SDS + Zentro Masonry Drill 12x160	12	160	100
Alpha	SPZ120210	Alpha SDS + Zentro Masonry Drill 12x210	12	210	150
Alpha	SPZ120260	Alpha SDS + Zentro Masonry Drill 12x260	12	260	200
Alpha	SPZ120310	Alpha SDS + Zentro Masonry Drill 12x310	12	310	250
Alpha	SPZ120450	Alpha SDS + Zentro Masonry Drill 12x450	12	450	390
Alpha	SPZ140260	Alpha SDS + Zentro Masonry Drill 14x260	14	260	200
Alpha	SPZ140450	Alpha SDS + Zentro Masonry Drill 14x450	14	450	390
Alpha	SPZ160260	Alpha SDS + Zentro Masonry Drill 16x260	16	260	200
Alpha	SPZ160450	Alpha SDS + Zentro Masonry Drill 16x450	16	450	390
Alpha	SPZ180250	Alpha SDS + Zentro Masonry Drill 18x250	18	250	190
Alpha	SPZ180450	Alpha SDS + Zentro Masonry Drill 18x450	18	450	390
Alpha	SPZ200250	Alpha SDS + Zentro Masonry Drill 20x250	20	250	190
Alpha	SPZ200450	Alpha SDS + Zentro Masonry Drill 20x450	20	450	390
Alpha	SPZ220250	Alpha SDS + Zentro Masonry Drill 22x250	22	250	190
Alpha	SPZ220450	Alpha SDS + Zentro Masonry Drill 22x450	22	450	390
Alpha	SPZ240250	Alpha SDS + Zentro Masonry Drill 24x250	24	250	190
Alpha	SPZ240450	Alpha SDS + Zentro Masonry Drill 24x450	24	450	390
Alpha	SPZ250250	Alpha SDS + Zentro Masonry Drill 25x250	25	250	190
Alpha	SPZ250450	Alpha SDS + Zentro Masonry Drill 25x450	25	450	390
Alpha	SPZ280250	Alpha SDS + Zentro Masonry Drill 28x250	28	250	190
Alpha	SPZ280450	Alpha SDS + Zentro Masonry Drill 28x450	28	450	390
Alpha	SPZ300250	Alpha SDS + Zentro Masonry Drill 30x250	30	250	190
Alpha	SPZ300450	Alpha SDS + Zentro Masonry Drill 30x450	30	450	390
Alpha	SPZ320450	Alpha SDS + Zentro Masonry Drill 32x450	32	450	390



SDS **Max** Zentro 4 Cutter with Carbide Tip (Metric)

The Alpha SDS Max range boasts outstanding Performance. German quality and design. Secondary cutters protect the drill bit in the event of reinforcement collision. Maximum energy transfer. Excellent performance. Long Life SDS MAX. Fully certified for drilling anchor holes. Shank diameter 18mm.

Brand	Code	Description	Diameter mm	Overall Length	Flute Length
Alpha	SXZ12340	Alpha SDS Max Masonry Drill 12mm x 340mm	12	340	200
Alpha	SXZ12540	Alpha SDS Max Masonry Drill 12mm x 540mm	12	540	400
Alpha	SXZ14340	Alpha SDS Max Masonry Drill 14mm x 340mm	14	340	200
Alpha	SXZ14540	Alpha SDS Max Masonry Drill 14mm x 540mm	14	540	400
Alpha	SXZ14920	Alpha SDS Max Masonry Drill 14mm x 920mm	14	920	800
Alpha	SXZ161620	Alpha SDS Max Masonry Drill 16mm x 1620mm	16	1620	
Alpha	SXZ16340	Alpha SDS Max Masonry Drill 16mm x 340mm	16	340	200
Alpha	SXZ16540	Alpha SDS Max Masonry Drill 16mm x 540mm	16	540	400
Alpha	SXZ16920	Alpha SDS Max Masonry Drill 16mm x 920mm	16	920	800
Alpha	SXZ181320	Alpha SDS Max Masonry Drill 18mm x 1320mm	18	1320	
Alpha	SXZ18340	Alpha SDS Max Masonry Drill 18mm x 340mm	18	340	200
Alpha	SXZ18540	Alpha SDS Max Masonry Drill 18mm x 540mm	18	540	400
Alpha	SXZ18920	Alpha SDS Max Masonry Drill 18mm x 920mm	18	920	800
Alpha	SXZ201320	Alpha SDS Max Masonry Drill 20mm x 1320mm	20	1320	
Alpha	SXZ20320	Alpha SDS Max Masonry Drill 20mm x 320mm	20	320	200
Alpha	SXZ20520	Alpha SDS Max Masonry Drill 20mm x 520mm	20	520	400
Alpha	SXZ20920	Alpha SDS Max Masonry Drill 20mm x 920mm	20	920	800
Alpha	SXZ221320	Alpha SDS Max Masonry Drill 22mm x 1320mm	22	1320	
Alpha	SXZ22320	Alpha SDS Max Masonry Drill 22mm x 320mm	22	320	200
Alpha	SXZ22520	Alpha SDS Max Masonry Drill 22mm x 520mm	22	520	400
Alpha	SXZ22920	Alpha SDS Max Masonry Drill 22mm x 920mm	22	920	800
Alpha	SXZ24320	Alpha SDS Max Masonry Drill 24mm x 320mm	24	320	200
Alpha	SXZ24520	Alpha SDS Max Masonry Drill 24mm x 520mm	24	520	400
Alpha	SXZ251320	Alpha SDS Max Masonry Drill 25mm x 1320mm	25	1320	
Alpha	SXZ25320	Alpha SDS Max Masonry Drill 25mm x 320mm	25	320	200
Alpha	SXZ25520	Alpha SDS Max Masonry Drill 25mm x 520mm	25	520	400
Alpha	SXZ25920	Alpha SDS Max Masonry Drill 25mm x 920mm	25	920	800
Alpha	SXZ26300	Alpha SDS Max Masonry Drill 26mm x 300mm	26	300	200
Alpha	SXZ26520	Alpha SDS Max Masonry Drill 26mm x 520mm	26	520	400
Alpha	SXZ281320	Alpha SDS Max Masonry Drill 28mm x 1320mm	28	1320	
Alpha	SXZ28370	Alpha SDS Max Masonry Drill 28mm x 370mm	28	370	200
Alpha	SXZ28570	Alpha SDS Max Masonry Drill 28mm x 570mm	28	570	400
Alpha	SXZ28920	Alpha SDS Max Masonry Drill 28mm x 920mm	28	920	800
Alpha	SXZ30370	Alpha SDS Max Masonry Drill 30mm x 370mm	30	370	200
Alpha	SXZ30570	Alpha SDS Max Masonry Drill 30mm x 570mm	30	570	400
Alpha	SXZ321320	Alpha SDS Max Masonry Drill 32mm x 1320mm	32	1320	
Alpha	SXZ32370	Alpha SDS Max Masonry Drill 32mm x 370mm	32	370	200
Alpha	SXZ32570	Alpha SDS Max Masonry Drill 32mm x 570mm	32	570	400
Alpha	SXZ32920	Alpha SDS Max Masonry Drill 32mm x 920mm	32	920	800
Alpha	SXZ351320	Alpha SDS Max Masonry Drill 35mm x 1320mm	35	1320	
Alpha	SXZ35370	Alpha SDS Max Masonry Drill 35mm x 370mm	35	370	200
Alpha	SXZ35570	Alpha SDS Max Masonry Drill 35mm x 570mm	35	570	400



Core Drill Bits

PDC Professional Dry Core Drill

Universal dry diamond core drill in all popular plumbers sizes up to 180mm. Slotted barrel provides efficient dust clearance and ease of removing drilled core. For brick and blockwork. Applications include: Medium and soft bricks, concrete blocks (lightweight and dense), abrasive concrete products. Occasional use in harder materials e.g. semi engineering bricks and clay products.

Code	Diameter (mm)	Length (mm)
DB00740	22	300
DB00750	28	300
DB00760	32	150
DB00770	38	150
DB00771	42	150
DB00780	48	150
DB00790	52	150
DB00800	65	150
DB00810	78	150
DB00811	82	150
DB00812	91	150
DB00813	102	150
DB00820	107	150
DB00830	117	150
DB00840	127	150
DB00841	142	150
DB00850	152	150
DB00860	162	150
DB00861	172	150
DB00870	182	150
DB00871	200	150



13mm A Taper Drill

Code DB02390

To suit UDCS and UDCL core adaptors



Drift Key

Code DB02410

To suit PCC and UDCL core adaptors



SDS Plus Adapter

Code DB02430

With 5/8" - 11 male fitting to suit UDCS and UDCL cores



Hex Adapter

Code DB02420

With 5/8" - 11 male fitting to suit UDCS and UDCL cores



Diamond Core Drills

Aero Core Drills

The Aero FW is a well proven coredrill best used for fast, wet cutting in hard aggregate concrete and steel reinforcement due to the high concentration of diamond in the segment.

In addition to the low friction 'Aero' golf ball design, the Aero FW segment is world recognised because of the well designed 'W' shape which provides more cutting edges, hence increasing the cutting speed.

- W-Shape gives the segment more cutting edges
- Larger diamonds in the segment increases the speed of cut, and also the life of the segment due to the high quality bond system
- Better Water coverage means that slurry is cleared out faster and there is more water around the point of cut
- Low Friction Design due to the unique shape ensures faster cutting and free cutting in steel

1 1/4" UNC, 450mm FW or F

Brand	Code	Size	Brand	Code	Size
Aero	UNC045/450	45mm	Aero	UNC112/450	112mm
Aero	UNC052/450	52mm	Aero	UNC117/450	117mm
Aero	UNC057/450	57mm	Aero	UNC122/450	122mm
Aero	UNC062/450	62mm	Aero	UNC127/450	127mm
Aero	UNC065/450	65mm	Aero	UNC132/450	132mm
Aero	UNC067/450	67mm	Aero	UNC142/450	142mm
Aero	UNC072/450	72mm	Aero	UNC152/450	152mm
Aero	UNC077/450	77mm	Aero	UNC158/450	158mm
Aero	UNC082/450	82mm	Aero	UNC162/450	162mm
Aero	UNC087/450	87mm	Aero	UNC172/450	172mm
Aero	UNC092/450	92mm	Aero	UNC182/450	182mm
Aero	UNC102/450	102mm	Aero	UNC192/450	192mm
Aero	UNC107/450	107mm	Aero	UNC200/450	200mm

1 1/4" UNC, 500mm FW or F

Brand	Code	Size	Brand	Code	Size
Aero	UNC212/500	212mm	Aero	UNC350/500	350mm
Aero	UNC225/500	225mm	Aero	UNC400/500	400mm
Aero	UNC250/500	250mm	Aero	UNC450/500	450mm
Aero	UNC275/500	500mm	Aero	UNC500/500	500mm
Aero	UNC300/500	300mm	Aero	UNC600/500	600mm
Aero	UNC325/500	325mm			

Aero Crown Core Drills

Aero Crown Core Drills have become proven for the speed of cut, and steel drilling capacities. These advantages come with no disadvantage to the working life of the Aero Crown.

1.5 x 320mm R½

Brand	Code	Size	Brand	Code	Size
Aero	CRJ12	12mm	Aero	CRJ35	35mm
Aero	CRJ14	14mm	Aero	CRJ37	37mm
Aero	CRJ16	16mm	Aero	CRJ38	38mm
Aero	CRJ18	18mm	Aero	CRJ40	40mm
Aero	CRJ20	20mm	Aero	CRJ42	42mm
Aero	CRJ22	22mm	Aero	CRJ45	45mm
Aero	CRJ24	24mm	Aero	CRJ50	50mm
Aero	CRJ25	25mm			
Aero	CRJ26	26mm			
Aero	CRJ28	28mm			
Aero	CRJ30	30mm			
Aero	CRJ32	32mm			



**WE ALSO
OFFER A
RETIPPING
SERVICE!**



Core Bits

Kea Diamond Tile Core Drills

Designed specifically for drilling through ceramic tiles, porcelain tiles, glass, and stone tiles. Our core drills feature high-quality diamond tips that offer superior precision and durability, allowing you to make clean, precise cuts quickly and effortlessly.

Brand	Code	Description
Kea	TSSDCD5	5mm diameter x M14
Kea	TSSDCD6	6mm diameter x M14
Kea	TSSDCD8	8mm diameter x M14
Kea	TSSDCD10	10mm diameter x M14
Kea	TSSDCDHEX16	16mm diameter Hex
Kea	TSSDCDHEX20	20mm diameter Hex



VB Core Bits

VB Core Bits are designed to be run on angle grinders because of the greater RPM and are more controllable to centre. VBCB bits will cut most construction products. 1 per packet.

Brand	Code	Description	Brand	Code	Description
Tusk	VBCB5	5mm diameter x M14	Tusk	VBCB32	32mm diameter x M14
Tusk	VBCB6	6mm diameter x M14	Tusk	VBCB35	35mm diameter x M14
Tusk	VBCB8	8mm diameter x M14	Tusk	VBCB45	45mm diameter x M14
Tusk	VBCB10	10mm diameter x M14	Tusk	VBCB50	50mm diameter x M14
Tusk	VBCB12	12mm diameter x M14	Tusk	VBCB55	55mm diameter x M14
Tusk	VBCB15	15mm diameter x M14	Tusk	VBCB60	60mm diameter x M14
Tusk	VBCB20	20mm diameter x M14	Tusk	VBCB65	65mm diameter x M14
Tusk	VBCB25	25mm diameter x M14			



Diamond Core Drill Sets

Welded Diamond Grit (Metric)

Brand	Code	Diameter	Description
Totalsite	TDCB-W5	5mm	5mm Diamond Core Drill
Totalsite	TDCB-W6	6mm	6mm Diamond Core Drill
Totalsite	TDCB-W8	8mm	8mm Diamond Core Drill
Totalsite	TDCB-W10	10mm	10mm Diamond Core Drill
Totalsite	TDCB-W12	12mm	12mm Diamond Core Drill
Totalsite	TDCB-W15	15mm	15mm Diamond Core Drill
Totalsite	TDCB-W20	20mm	20mm Diamond Core Drill





OXIDES

OXIDES

Oxides

Permacolour Colourmix

Permacolour Powdered Integral Colour iron oxide pigment, is pre-packaged in water-soluble bags that are added at the concrete batch plant or on site by the contractor. Permacolour Powdered Colour disperses evenly throughout the concrete mix and complies with ASTM C979 Pigments for Integrally Coloured Concrete.

Permacolour Colourmix Integral Colour is a new innovated process of adding colour to concrete. For many years liquid colour has been used to produce the desired colour range throughout New Zealand, but now Permacolour has a more cost effective product that is taking the place of liquid colour. It is easier to use, safer to dose the mix and stronger in colour. Permacolour Colourmix Integral Colour is premium grade oxide supplied in high quality cold water "aquasac" bags with an outer protective bag. The outer bag may be paper or plastic and must be completely removed before placing the water soluble bag into the mixer bowl. This should be done prior to the addition of aggregates, cement and final water. If there is a need to add the colour onsite, the colour should be mixed for 10 minutes at high speed and the same exact time for each load.

The bags are available in 1kg, 5kg and 10kg for all colours with some of the blacks (except carbon blacks) also available in 2kg and 20kg bags. With this range of different size bags, there is no need for any weighing at all, which eliminates any mess that normally occurs when working with oxides. There is very little waste, no buckets that some systems have and the paper bag is biodegradable.

Powdered Integral Colour

Brand	Code	Description
Permacolour	NPCPLITHIUM-WS10	Lithium coloured oxide 10kg water soluble bag = 1m3
Permacolour	NPCPSOAP-WS10	Soapstone coloured oxide 10kg water soluble bag = 1m3
Permacolour	NPCPCANVAS-WS05	Canvas coloured oxide 5kg water soluble bag = 1m3
Permacolour	NPCLIMES-WS10	Limestone coloured oxide 10kg water soluble bag = 1m3
Permacolour	NPCPLATTE-WS10	Latte coloured oxide 10kg water soluble bag = 1m3
Permacolour	NPCPSTONE-WS05	Stonefish coloured oxide 5kg water soluble bag = 1m3
Permacolour	NPCPCARGO-WS10	Cargo coloured oxide 10kg water soluble bag = 1m3
Permacolour	NPCPBLUE-WS05	Bluegrass coloured oxide 5kg water soluble bag = 1m3
Permacolour	NPCPLUSTRE-WS10	Lustre coloured oxide 10kg water soluble bag = 1m3
Permacolour	NPCPSEPIA-WS10	Sepia coloured oxide 10kg water soluble bag = 1m3
Permacolour	NPCPSTRAW-WS05	Straw coloured oxide 5kg water soluble bag = 1m3
Permacolour	NPCPMOSS-WS05	Moss coloured oxide 5kg water soluble bag = 1m3
Permacolour	NPCPTOBAC-WS10	Tobasco coloured oxide 10kg water soluble bag = 1m3
Permacolour	NPCPCASH-WS05	Cashmere coloured oxide 5kg water soluble bag = 1m3
Permacolour	NPCPGOLDC-WS10	Gold Coast coloured oxide 10kg water soluble bag = 1m3
Permacolour	NPCACTUS-WS10	Cactus coloured oxide 10kg water soluble bag = 1m3
Permacolour	NPCPPOTT-WS10	Pottery coloured oxide 10kg water soluble bag = 1m3
Permacolour	NPCPMART-WS05	Martini coloured oxide 5kg water soluble bag = 1m3
Permacolour	NPCPSIENNA-WS05	Sienna coloured oxide 5kg water soluble bag = 1m3
Permacolour	NPCPMINT-WS10	Mint coloured oxide 10kg water soluble bag = 1m3
Permacolour	NPCPCHOC-WS10	Chocolate coloured oxide 10kg water soluble bag = 1m3
Permacolour	NPCPAGEB-WS10	Aged Bronze coloured oxide 10kg water soluble bag = 1m3
Permacolour	NPCCTERRA-WS10	Terracotta coloured oxide 10kg water soluble bag = 1m3
Permacolour	NPCPTEAL-WS10	Teal coloured oxide 10kg water soluble bag = 1m3
Permacolour	NPCPLCASSG-WS10	Classic Grey coloured oxide 10kg water soluble bag = 1m3
Permacolour	NPCPF9270-WS05	Metal Grey coloured oxide 5kg water soluble bag = 1m3
Permacolour	NPCPCHAR-WS10	Charcoal coloured oxide 10kg water soluble bag = 1m3
Permacolour	NPCPJETB-WS20	Jet Black coloured oxide 20kg water soluble bag = 1m3
Permacolour	NPCPF9270-WS20	Black Velvet coloured oxide 10kg water soluble bag = 1m3
Permacolour	NPCPF9270-WS10	Gun Smoke coloured oxide 10kg water soluble bag = 1m3
Permacolour	NPCPF9270-WS10	Carbon Black coloured oxide 10kg water soluble bag = 1m3
Permacolour	NPCPF9675-WS10	Black Magic coloured oxide 10kg water soluble bag = 1m3





CONCRETE CONSUMABLES

Release Agents

Rockbond Form Release

General purpose oil base release agent for steel moulds, formwork and concrete beds.

Brand	Code	Size
Rockbond	RB7.18-5	5L
Rockbond	RB7.18-20	20L
Rockbond	RB7.18-200	200L
Rockbond	RB7.18-1000	1000L

Rockbond Tilt Release

A general-purpose bond breaker for tilt slab construction and other applications where concrete is poured on to concrete.

Brand	Code	Size
Rockbond	RB7.21-5	5L
Rockbond	RB7.21-20	20L
Rockbond	RB7.21-200	200L

Rockbond Bio-Lease

Vegetable based release agent for steel moulds & formwork.

Brand	Code	Size
Rockbond	RB7.30-20	20L
Rockbond	RB7.30-200	200L

Rockbond Smooth Release

Mineral based release agent for manufacturing pavers.

Brand	Code	Size
Rockbond	RB7.35-5	5L
Rockbond	RB7.35-20	20L

EcoRatio Betopro 570

Water-based release agent that produces exceptional finish

Brand	Code	Size
Rockbond	RB10.60-20	20L
Rockbond	RB10.60-200	200L

EcoRatio Betopro WX-G

Wax Agent that ensures inserts can be removed quickly and easily without damage

Brand	Code	Size
Rockbond	RB10.65-10	10L

Surface Retarders

Rockbond Surface Retarder

For exposed aggregate work 0-20MPa

Brand	Code	Size
Rockbond	RB7.16-5	5L
Rockbond	RB7.16-20	20L
Rockbond	RB7.16-200	200L

Rockbond Surface Retarder - Plus

For exposed aggregate work 20MPa and over and in hot weather

Brand	Code	Size
Rockbond	RB7.17-5	5L
Rockbond	RB7.17-20	20L
Rockbond	RB7.17-200	200L

Rockbond Surface Retarder - Plus Extra

Designed for mechanical joints in concrete over 40MPa

Brand	Code	Size
Rockbond	RB7.17EX-5	5L
Rockbond	RB7.17EX-20	20L
Rockbond	RB7.17EX-200	200L

Rockbond Form-Tard Plus

Paint on Surface Retarder for concrete moulds and form-work (Solvent Free)

Brand	Code	Size
Rockbond	RB7.24-20	20L



Curing & Anti-Evaporation



Rockbond Slabcure

Sodium silicate based curing compound with no effect on future painting or floor adhesives

Brand	Code	Size
Rockbond	RB7.10-5	5L
Rockbond	RB7.10-20	20L
Rockbond	RB7.10-200	200L

Rockbond Membrane Cure

Degradable membrane cure meeting industry standards

Brand	Code	Size
Rockbond	RB7.11-20	20L
Rockbond	RB7.11-200	200L

Rockbond Supa-Cure

Wax curing membrane that conforms to AS3799

Brand	Code	Size
Rockbond	RB7.12-20	20L
Rockbond	RB7.12-200	200L

Rockbond Evaporation Retarder

Stops cracking in hot or dry weather while concrete is still being worked.

Brand	Code	Size
Rockbond	RB7.27-20	20L
Rockbond	RB7.27-200	200L

Rockbond Concrete Conditioner

For a hard, dust free concrete floor.

Brand	Code	Size
Rockbond	RB7.19-20	20L
Rockbond	RB7.19-200	200L

Remedial Products

Rockbond Epoxy Mortar

Very high strength adhesive mortar.

Brand	Code	Size
Rockbond	RB8.04-8	8L
Rockbond	RB8.04-20	20L

Rockbond Repair Mortar

Super strong hi-build mortar

Brand	Code	Size
Rockbond	RB1.04-25	25kg

29Y40 Concrete Modifier

To improve the adhesion, flexibility and workability of cementitious mortars, plasters and renders and can be used as a primer for concrete, brickwork, hardiplank or substrates diluted 1:3 with water

Brand	Code	Size
Nuplex	29Y40-1	1L
Nuplex	29Y40-2	2L
Nuplex	29Y40-5	5L
Nuplex	29Y40-20L	20L

Rockbond Primer for Steel

Protects reinforcing exposed during concrete repairs

Brand	Code	Size
Rockbond	RB1.00-4	4kg
Rockbond	RB1.00-25	25kg

Rockbond Fastrock Super Accelerated Mortar

Very fast-setting mortar for plugging leaks, and under water applications.

Brand	Code	Size
Rockbond	RB3.09-4	4kg
Rockbond	RB3.09-25	25kg

Rockbond Fairing Coat

Great colour match for cosmetic repairs to new concrete.

Brand	Code	Size
Rockbond	RB7.04-20	20kg

Mould Preparations & Maintenance

Rockbond Precast Mould Cleaner

Non-flammable mould cleaner and silicone remover.

Brand	Code	Size
Rockbond	RB10.50-24	24kg

Rockbond Industrial Degreaser

Great for cleaning up release agent residue etc.

Brand	Code	Size
Rockbond	RB10.47-20	20L
Rockbond	RB10.47-200	200L

Rockbond Steel Mould Protector MG

Great for cleaning up release agent residue etc. 0-6 months

Brand	Code	Size
Rockbond	RB10.40-20	20L

Rockbond Steel Mould Protector HG

Anti-corrosion treatments for steel moulds. 6-12 months

Brand	Code	Size
Rockbond	RB10.41-20	20L

Concrete Additives

Rockbond Water Reducer

Increases strength by reducing water

Brand	Code	Size
Rockbond	RB6.13-20	20L
Rockbond	RB6.13-200	200L

Rockbond Super Plasticiser

For free flowing concrete to fill all voids

Brand	Code	Size
Rockbond	RB6.15-20	20L
Rockbond	RB6.15-200	200L

Rockbond Hyper-Plasticiser

Maintains flowability and allows major water reduction of over 30%. Produces self compacting concrete.

Brand	Code	Size
Rockbond	RB6.16N-20	20L
Rockbond	RB6.16N-200	200L

Rockbond CF Accelerator

Chloride-Free accelerator for concrete

Brand	Code	Size
Rockbond	RB6.11-20	20L
Rockbond	RB6.11-200	200L

Rockbond Retarder

Slows down concrete initial set in hot weather

Brand	Code	Size
Rockbond	RB6.18-20	20L
Rockbond	RB6.18-200	200L

Rockbond Microsilica

Concrete densifier and strengthening agent

Brand	Code	Size
Rockbond	RB6.08-20	20L



Rockbond Waterproof Powder

To reduce permeability and stop efflorescence

Brand	Code	Size
Rockbond	RB6.05-4	4kg
Rockbond	RB6.05-25	25kg

Rockbond Cement Accelerator

Mix with neat cement and stop a leak in 2 minutes. Ideal for manhole connections.

Brand	Code	Size
Rockbond	RB6.21-4	4kg
Rockbond	RB6.21-25	25kg

Rockbond A220 Expansion Agent

An expansion powder for blockfill grout - helps fill voids and reduces settlement and cracking 1kg/m³. Supplied in water soluble bags.

Brand	Code	Size
Rockbond	RB6.01	20L

Rockbond Mortar Plasticiser

Lay more bricks faster with this great mortar plasticiser. Improves the workability of mortars and renders

Brand	Code	Size
Rockbond	RB6.22-5	5L
Rockbond	RB6.22-20	20L

Acid Etching & Cleaning

Rockbond Crete-Blaster

Safe to use concrete cleaner - non-corrosive. Clean concrete splashes off cars, glass & tools

Brand	Code	Size
Rockbond	RB10.14-20	20L
Rockbond	RB10.14-200	200L

Rockbond Crete-Blaster Extra

Safe to use concrete cleaner - non-corrosive. Clean concrete splashes off cars, glass & tools

Brand	Code	Size
Rockbond	RB10.14EX-20	20L
Rockbond	RB10.14EX-200	200L

Rockbond Eco Mask

Waterbased environmentally-friendly spray on masking agent that is great for protecting equipment.

Brand	Code	Size
Rockbond	RB10.43-5	5L

Sealers & Waterproofers

Clearseal Concrete Sealer

Is a gloss acrylic solvent based surface coating and sealer.

Brand	Code	Size
Totalsite	DG01-5	5L
Totalsite	DG01	20L
Totalsite	DG02	200L

Xylene Concrete Sealer Thinners

Commonly used for the thinning of Clearseal. It is good at cleaning up oil based products like paints, stains and other synthetic products without damaging the surfaces they are on.

Brand	Code	Size
Totalsite	XYLENE1L	1L
Totalsite	XYLENE5L	5L
Totalsite	XYLENE20L	20L
Totalsite	XYLENE200L	200L

Homecare Solvosil Spirit Based Sealer

Protection from leakage, dampness, moss and mould. Prevents rain and run off water penetrating wall and favades whilst allowing them to breathe. Protects from freeze thaw erosion. Quick drying. High penetration power. Long term surface protection - 10 years plus. Especially suited to Oamaru Stone, Lime stones, concrete, renders and bricks.

Brand	Code	Size
Totalsite	SBSIL4L	4L
Totalsite	SBSIL20L	20L
Totalsite	SBSIL200L	200L



Hydrochloric Acid

A highly concentrated, strong acid solution. Ideal for etching masonry surfaces prior to painting and/or glazing

Brand	Code	Size
Totalsite	ALR0099	2L
Totalsite	ALM0099	5L
Totalsite	2181010	20L

BackSet

Biodegradable cement softener for cleaning of hardened cement base products on tools and equipment

Brand	Code	Size
Totalsite	BKST-5LTR	5L
Totalsite	BKST-20LTR	20L

Epotread 1000

Hardwearing, solvent free epoxy coating with excellent chemical resistance, making it an ideal surface for floor areas subject to vehicle/foot traffic or chemical spill. Available colours: Clear, Grey, Cloud Grey, Dark Grey, Charcoal, White.

Brand	Size
Epotread	4L Kit
Epotread	8L Kit
Epotread	20L Kit

Homecare Waterbased Silicone

A waterbased silicone impregnation agent which repels water and allows walls to breathe, specially designed for the water-repellent treatment of buildings and building materials, including concrete tiles, paths, foundations, Summerhill Stone, concrete blocks and other porous building materials

Brand	Code	Size
Totalsite	WBSIL1L	1L
Totalsite	WBSIL2L	2L
Totalsite	WBSIL5L	5L
Totalsite	WBSIL20L	20L
Totalsite	WBSIL200L	200L

Rockbond Leak Stop

From damp basements to leaking tanks LEAK STOP is the product of choice. RB 7.06 utilises crystal growth technology to seal seeping concrete from EITHER side.

Brand	Code	Size
Rockbond	RB7.06	5L

Homecare Moss & Mould Kill

This product is a highly concentrated waterbased formula for widespread and long-term control of moss and mould and associated areas.

Brand	Code	Size
Totalsite	MM1L	1L
Totalsite	MM2L	2L
Totalsite	MM5L	5L
Totalsite	MM20L	20L
Totalsite	MM200L	200L

Acetone

Often used as a cleaning solvent. Acetone is also a common paint thinner.

Brand	Code	Size
Damar	ALR0123	1L
Damar	ALK0123	20L
Damar	AACET10009	200L

Mineral Turpentine

Used as paint thinner of oil based paint

Brand	Code	Size
Totalsite	DG01-5	5L
Totalsite	DG01	20L
Totalsite	DG02	200L

Moss & Mould Kill



Mix & Pour Floor Repair

Mix & Pour Floor Repair

From rubber boots and cattle hooves that scuff farm floors to the weight of forklift trucks and other large machinery, the workload at a dairy farm is immense and unforgiving.

The result is often cracks in the flooring. Cracks are a serious problem for flooring because they compromise sanitation when spillage seeps into those cracks and crevices.

Rockbond RB2.25 Mix and Pour is a high performance, quick setting floor screed designed specifically with maintaining dairy farm sheds and feedlots.

This product helps ensure the sanitary upkeep of your milk production and maintenance of the buildings.

Repair after the first milking and the surface will be ready to walk on for the second milking later the same day.

Brand	Code	Size
Rockbond	RB2.25-10	10L

Perfect for Dairy Sheds



Sealants

Gorilla Pro Gun

Code 21100

290ml – 375ml. Attractive hangsell packaging. High quality mechanism. Industrial construction. Light weight ergonomic design.



Fixall Skeleton Gun

Code 11390

300ml – 375ml. Light weight ergonomic design. Nozzle cleaning tool. Competitively priced. Will take 300ml – 375ml cartridges.



Holdfast 600ml Sausage Gun

Code 21116

Top quality 340mm Sausage gun to fit the 600ml sausages. Also will take 265mm cartridges. Replacement nozzles available.



Panasonic Electric Sausage Gun

Code EY3641LR1S57

New high-performance 4.2Ah Li-ion battery pack. 50min usable and 60min full charging. Light weight 2.8kg (incl. battery). Electric speed control. Fully automatic decompression. Includes one battery pack.



Fixall 220 MS Sealant 425gr Cartridge

FixAll 220 is a high performance MS sealant with superior flexibility, which makes it ideal for expansion joints or joints subject to (high) movement. High performance MS sealant. Will stick to damp surfaces. UV resistant. Paintable 1 hour after application (under normal conditions).

Brand	Code	Description
Fixall	20067	600ml colour white, box qty 12
Fixall	20068	600ml colour grey, box qty 12
Fixall	20070	425gr colour black, box qty 12



Gorilla Boltfix Anchoring Adhesive

Code 21423

Boltfix Anchoring Adhesive is a rapid curing 2 part chemical anchoring system based on epoxy acrylate. Boltfix Anchoring Adhesive is styrene free. It is suitable for exterior applications. Pressure-free securing of threaded rods. Reinforcement bars, profiles etc.



Holdfast Carbond 940FC Automotive PU Sealant

High quality polyurethane based sealant & adhesive. High bond strength. Can be sanded and painted. Resistant to many chemicals. Waterproof.

Brand	Code	Description
Holdfast	20054	310ml colour black
Holdfast	20055	310ml colour white
Holdfast	20064	600ml colour black
Holdfast	20066	600ml colour white
Holdfast	20069	600ml colour grey



Toptec Industrial Silicone 300ml – Clear

Code 60080

A fast curing neutral cure, fully elastic one-component joint. Sealant based on silicones which meets ISO 11600 F+G 25LM. Low modulus, very easy application, permanent colour, NZ UV resistant, fast skin forming and stays elastic after curing.



Fixall 220 MS Sealant 600ml Sausage

Top quality 340mm Sausage gun to fit the 600ml sausages. Also will take 265mm cartridges. Replacement nozzles available.

Brand	Code	Description
Fixall	20073	600ml colour white, box qty 12
Fixall	20072	600ml colour grey, box qty 12
Fixall	20071	600ml colour black, box qty 12



Gorilla Facade Elastic Joint Sealant

Code 20173

High quality, polyurethane based elastic joint sealant. Excellent resistance to UV radiation and weathering.

Temperature resistance -30°C to +90°C. All usual building & industrial joints.



Micara Armaflex 40FC Flooring Sealant

Code 42708

600ml grey. High quality, excellent adhesion. Excellent tear and chemical Resistance. Easy to gun and tool. Permanently elastic.



Gorilla Firestop MS FR

Code 56219

High quality joint sealant, high adhesive strength with excellent elasticity. For use in high movement joints in construction, automotive, marine applications where a tough flexible rubber is required with good fire retardant characteristics.



Gator PEF Backing Rods

Controls the correct joint depth. Ensures appropriate movement of sealant. Complies with ASTM standard as per NZ Building Code. Water resistant, no water absorption.

Brand	Code	Size
Holdfast	39172	6mm x 50mr Small Reel
Holdfast	39171	8mm x 50mr Small Reel
Holdfast	39170	10mm x 50mr Small Reel
Holdfast	39169	13mm x 50mr Small Reel
Holdfast	39164	15mm x 50mr Small Reel
Holdfast	39168	20mm x 50mr Small Reel
Holdfast	39167	25mm x 50mr Small Reel
Holdfast	39166	30mm x 50mr Small Reel



Masking Tapes & Films



Scotch Brand Pro Strength Duct Tape

Code 1260

Heat resistant 48mm x 54.6m. The tape includes a high-tack adhesive that holds tight to most surfaces. Polyethylene bonded to cloth duct tape is weather-resistant and moisture-resistant and tears easily by hand. Industrial construction. Light weight ergonomic design.



Black PVC Tape 48mm

Code 3033-30X48-B

Plasticized PVC Tape coated with a special primed rubber based adhesive. An excellent premium tape with good resistance to weather, moisture, UV & aging. Excellent for heavy duty joining & sealing applications.



Autospec Tape

High performance grade for brush, roller & spray masking Automotive paint masking applications- solvent resistant Extra strength for Industrial holding, bundling & packing applications. Up to 3 days exterior masking with excellent conformability.

Brand	Code	Size	Box Qty
NZ Tape	8B-18	18mm x 50m	48
NZ Tape	8B-24	24mm x 50m	36
NZ Tape	8B-36	36mm x 50m	24
NZ Tape	8B-48	48mm x 50m	20



Waterproof Cloth Tape

Extra thick rubber adhesive layer for high tack, permanent bond. High strength 80 mesh fabric scrim backing for superior holding. Excellent water and moisture resistance for weatherproofing and sealing. Used for heavy duty protection, bundling, reinforcing, repairing, sealing.

Brand	Code	Size
NZ Tape	0116W-18	18mm
NZ Tape	0116W-24	24mm
NZ Tape	0116W-36	36mm
NZ Tape	0116W-48	48mm

Pre Taped Masking Film

Cover Quick Pre-Taped Masking Film Refill.
Recommended for indoor masking of walls, partitions, windows and door openings. Fits CQ140/33 Dispenser.

Brand	Code	Size
CQ	CQ140/33RE	140cm drop x 33m long
CQ	CQ180/33RE	180cm drop x 33m long
CQ	CQ240/33RE	240cm drop x 16m long



ProCover Pre Taped Masking Film 1500 x 16m Refill

Premium green cloth tape. 60 day safe release on exterior. Flake resistant treated film. Each roll comes with 16m of film. 1500mm drop x 16m length.

Brand	Code	Size
CQ	PF-1500RE	1500mm x 16m



Pre Folded Masking Film

Heavy Duty 15 micron film. Treated with a unique formula that attracts overspray and reduces flaking. Fits all Hand Masking Dispensers including QM-5000.

Brand	Code	Size
CQ	CQMF-1248	1.2m x 48m
CQ	CQMF-1824	1.8m x 24m
CQ	CQMF-2424	2.4m x 24m
CQ	CQMF-3616	3.6m x 16m



Paper Masking Rolls

Easy Mask General Purpose Masking Paper. Brown general purpose masking paper formulated for water based materials: plaster, drywall, texture, latex and acrylic paints. Ideal for masking off windows and door trim prior to painting.

Brand	Code	Size
Almax	12906	150mm x 55m
Almax	12912	300mm x 55m



Coating Applicators



CQ All Paints 230mm Roller Kit

Code GS-230-12-KIT

2 x 8mm gold stripe micro fibre roller sleeves.
Heavy duty 5 roller frame. Suitable for all paints.
Sturdy 230mm roller tray.



Heavy Duty Roller Frame

Heavy duty 5 wire cage frame with threaded handle.
8mm shank, universal pole thread, reinforcing bands on handles.

Brand	Code	Size
CQ	N-1049	230mm
CQ	N-1056	270mm



Wooster Pro Doo-Z Roller - 450 x 13mm

All paints contractor sleeve. Suitable for all paints, urethanes epoxies. Very good solvent resistance, high density thermobonded woven pile.

Brand	Code	Size
Wooster	RR643-450	13mm
Wooster	RR644-450	20mm



Gold Stripe Industrial Rollers 270mm

All paints contractor sleeve. Suitable for all paints, urethanes epoxies. Very good solvent resistance, high density thermobonded woven pile. 270mm wide.

Brand	Code	Size
CQ	GS-270-12	12mm
CQ	GS-270-18	18mm



Gold Stripe Industrial Rollers 230mm

All paints contractor roller sleeve, Suitable for all coatings. High density thermobonded woven pile. 230mm wide.

Brand	Code	Size
CQ	GS-230-6	6mm
CQ	GS-230-18	18mm
CQ	GS-230-20	20mm



Tradegear Industrial Brush

Natural wood handle, white 100% hog bristle nickel plated ferrule, good bristle length and bulk. Favourite of the marine industry for gel coats, varnish, acetones and solvents.

Brand	Code	Size
Tradegear	7070/25	25mm
Tradegear	7070/38	38mm
Tradegear	7070/50	50mm
Tradegear	7100/63	63mm
Tradegear	7070/75	75mm
Tradegear	7070/100	100mm

Protective Wear PPE



Rig-Master Gloves

Code E320

Heavy weight fully dipped blue nitrile glove for full hand protection. 12 pairs per box/120 pairs per carton.



Activgrip Lite Gloves

Code AGL

Towa ActiveGrip MICROFINISH™ coating. A 15-gauge seamless liner and ergonomic design assure a maximum comfort and minimum hand fatigue. Extra coating of thumb area for extra safety. 12 pairs per box/144 pairs per carton.



Powergrab Plus Gloves

Code PGP

Towa Powergrab Plus, MICROFINISH™ coating. Extra coating of thumb area for extra safety. Feel the difference with MICROFINISH™ latex coating for outstanding wet and dry handling. 12 pairs per box/72 pairs per carton.



Powergrab Thermo Gloves

Code PGT

Towa Powergrab thermal lined MICROFINISH™ coating. Napped acrylic liner for cold conditions. Extra coating of thumb area for extra safety. 12 pairs per box/72 pairs per carton.



Thermo Gloves

Code OR653T

Towa 653 soft textured PVC with removable thermo liner. Removable, washable napped acrylic thermal liner. Anti-bacterial treatment is applied to the liner for improved hygiene. 12 pairs per box/72 pairs per carton.



Polycotton Gloves

Code E100 (without dots) or E150 (with dots)

7 gauge knit for strength and ventilation. Can be reversed and used on both sides (E100). Bleached with black PVC dot grip on one side for extra grip (E150).

12 pairs per box/300 pairs per carton.



'High Five' High Risk Latex Gloves

Code MDLHR-M | MDLHR-L | MDLHR-XL

Tough powder free high risk latex disposable gloves. Extended 30cm cuff for extra protection. Industrial skin protection. 50 pairs per box/10 boxes per carton.



'High Five' Industrial Nitrile Gloves

Code MDNDF-M | MDNDF-L | MDNDF-XL

Non latex powder free high quality nitrile rubber, tailored fit Industrial & Medical grade approved. Paint, silicon, Oil and abrasion resistant. 100 pairs per box/10 boxes per carton.



'High Five' Industrial Nitrile

Code MDNHD-M | MDNHD-L | MDNHD-XL

Superior puncture and abrasion resistance. 6mil - Stronger, thicker, more chemical resistant. Latex free - 100% nitrile. Distinctive black colour to mask stains. 100 pairs per box.



Prochoice Tradie & Painters Respirator Kit

Code HMA1P2

Suitable for trade application where P2 rating and organic vapour protection is required. Kit contains: 1 x Half Mask Respirator (HMTMP), 1 x pair P2 Cartridges (PCP2).



Prochoice P2 Prefilter to suit ProCartridges

Code PCFP2

For use with ProCartridge. Provides protection against mechanically thermally generated particles. Lightweight pads fit inside ProCartridge gas cartridge easy replacement system.



Prochoice Filter Cartridges for HMA1P2

Code PCP2

For use on Prochoice Twin Filter Half Mask. P2 cartridges protects against mechanical and thermally generated particles. Replaceable dust filter system. Easy 'Lock-on system' to ProChoice Half Mask. Comes Complete with a P2 ProChoice Filter and retainer caps.



Velocity Safety Glasses - Smoke

Code 8002

Standards certified to AS/NZS 1337.1 medium impact. Anatomically shaped wrap around lens offers a high degree of safety. Optically correct for greater visual accuracy and awareness. 99.9% UV protection for outdoors.



G-Max Premium Goggles

Code GMAX

AS/NZS 1337.1:2010 standards certified. Panoramic 180° field of vision. Suitable for use over prescription glasses. Outstanding ventilation system.



Magnum Safety Glasses

Code 1700 (clear) or 1702 (smoke)

AS/NZS 1337.1 medium impact protection, anti-scratch UV400 lens. Anti-fog coated lens ideal for use with dust masks and humid conditions. 100% UV protection for outdoor wear.



Totalsite Supplies are your local suppliers of Graco Airless Paint Sprayers and accessories. Feel free to contact us at any time to discuss your requirements. We ship Airless Sprayers nationwide and provide after-sales service and support. We also offer full service and repairs with parts available.

South Island Service Agents

With a particular eye for detail, we ensure all repair and warranty work is completed in a timely manner to ensure the customer is up and running with their equipment. Graco parts available. If your machine is not running at 100% capacity, give our team a call to book your machine in. Back up hire units are also available.





LADDERS & PLATFORMS

Aluminium Platform

Easy Access Platform Ladder

Trade Platform Ladder. Riveted Rungs, 180kg weight limit and has a 2 year warranty.



Code	Platform Height	Steps
OXPL02	0.6M	2 step
OXPL03	0.9M	3 step
OXPL04	1.2M	4 step
OXPL06	1.8M	6 step
OXPL08	2.4M	8 step

Easy Access Adjustable Platform Ladder

Trade Adjustable Platform Ladder. Riveted Rungs, 200kg weight limit.



Code	Platform Height	Steps
OXTPL03-05	0.84-1.44M	3-5 step
OXTPL04-07	1.15-2.02M	4-7 step
OXTPL05-09	1.44-2.60M	5-9 step

Bailey Adjustable Platform Ladder

Quickly converts from a 3 step platform stepladder to a 4, 5, or 6 step platform stepladder using a single handed operation. 170kg weight limit.



Code	Platform Height	Steps
FS13999	0.85-1.71M	3-6 step

Bailey P150 Platform Ladder

Designed to provide users with an exceptionally lightweight yet highly functional platform stepladder. 150kg weight limit.



Code	Platform Height	Steps
FS13580	0.9M	3 step
FS13581	1.2M	4 step
FS13582	1.5M	5 step
FS13583	1.8M	6 step

Bailey Job Station Platform Ladder

Professional Platform Ladder with wheels. 170kg weight limit. 2 year warranty.



Code	Platform Height	Steps
FS13538	0.9M	3 step
FS13539	1.2M	4 step
FS13540	1.5M	5 step
FS13541	1.8M	6 step
FS13542	2.03M	7 step
FS13543	2.32M	8 step
FS13544	2.91M	10 step
FS13545	3.60M	12 step

Warthog Platform Ladder

Industrial Platform Ladder. Welded Rungs, 200kg weight limit. Castors & full surround handrail available. 10 year warranty.



Code	Height	Steps
WHPL02	0.6M	2 step
WHPL03	0.9M	3 step
WHPL04	1.2M	4 step
WHPL05	1.5M	5 step
WHPL06	1.8M	6 step
WHPL07	2.1M	7 step
WHPL08	2.4M	8 step
WHPL09	2.7M	9 step
WHPL10	3.0M	10 step

Aluminium Dual Purpose

Easy Access Dual Purpose Ladders

Trade Dual Purpose Ladder. Braced side arms to improve stability and doubling as a handy tool tray. 150kg weight limit.



Code	Height	Steps
OXSE06	1.8M	6 step
OXSE07	2.1M	7 step
OXSE08	2.4M	8 step

Bailey Pro Dual Purpose Ladders

Professional Dual Purpose Ladder. Punchlock rungs, 150kg weight limit and 2 year warranty.



Code	Height	Steps
FS13988	1.8M	6 step
FS13989	2.1M	7 step
FS13990	2.4M	8 step

Warthog Dual Purpose Ladders

Industrial Dual Purpose Ladder. Welded rungs, 180kg weight limit and 10 year warranty.



Strong!

Code	Height	Steps
WHSE04	1.2M	4 step
WHSE05	1.5M	5 step
WHSE06	1.8M	6 step
WHSE07	2.1M	7 step
WHSE08	2.4M	8 step
WHSE09	2.7M	9 step
WHSE10	3.0M	10 step

Telescopic Ladders

Easy Access Telescopic Ladder

Trade All-in-One Telescopic Ladder. 150kg Weight Limit.



Code	Height
OXTL03	0.9 - 3.3M
OXTL04	1.2 - 4.5M
OXTL05	1.5 - 5.7M

Bailey Telescopic Ladder

The Bailey FS13644 converts into four different configurations, a double sided stepladder, a single straight ladder, two individual trestles and a telescopic adjustable ladder. 135kg load rating.



Code	Height
FS13644	2.3 - 4.5M

Single Ladders

CSL Single Ladders

Trade Single Ladder.
D shaped step.
150kg weight limit



Code	Height	Steps
CSL3.0	3.0M	7 step
CSL3.6	3.6M	9 foot
CSL4.8	4.8M	13 step
CSL5.4	5.4M	17 step

Double Sided Ladders

Easy Access Double Sided Ladder

Trade Double Sided Ladder. Heavy duty ladder feet, a huge 180kg weight limit.

Code	Height	Steps
OXDS02	0.6M	2 step
OXDS03	0.9M	3 step
OXDS04	1.2M	4 step



Bailey Pro Double Sided Ladder

Professional Double Sided Ladder. Punchlock Rungs, 150kg weight limit and 2 year warranty.

Code	Height	Steps
FS13960	0.9M	3 step
FS13961	1.2M	4 step
FS13963	1.8M	6 step
FS13965	2.4M	8 step



Warthog Double Sided Ladder

Industrial Double Sided Ladder. Welded Rungs, 180kg weight limit and 10 year warranty.

Code	Height	Steps
WHDS02	0.6M	2 step
WHDS03	0.9M	3 step
WHDS04	1.2M	4 step
WHDS05	1.5M	5 step
WHDS06	1.8M	6 step
WHDS07	2.1M	7 step
WHDS08	2.4M	8 step
WHDS09	2.7M	9 step



Aluminium Extension Ladders

Bailey Pro Extension

Professional Extension Ladder. Punchlock Rungs, 150kg weight limit and 2 year warranty.



Code	Height	Steps
FS13897	2.5-4.0m	8+
FS13898	3.1-5.3m	10+
FS13899	3.7-6.5m	12+
FS13900	4.4-7.7m	14+
FS13901	5.0-9.0m	16+
FS13902	5.6-10.0m	18+
FS13903	6.2-11.0m	20+



Bailey Pro Extension with Leveller Feet

Professional Extension Ladder. Punchlock Rungs, 150kg weight limit and 2 year warranty.



Code	Height	Steps
FS13905	3.18-5.01m	10 Step
FS13906	3.79-6.23m	12 Step



Order Pickers

Warthog Standard Order Pickers

Standard Order Picker with wheels & handrail. ladder folds flat to assist with storage and handling. Sturdy; fully welded joints, no rivets to work loose over time. 180kg weight limit.

Code	Platform Height	Steps
WHOP05/WC	1.5M	5 step
WHOP06/WC	1.8M	6 step
WHOP07/WC	2.1M	7 step
WHOP08/WC	2.4M	8 step
WHOP09/WC	2.7M	9 step
WHOP10/WC	3.0M	10 step
WHOP11/WC	3.3M	11 step
WHOP12/WC	3.6M	12 step



Warthog Heavy Duty Order Picker

Heavy Duty Order Picker with wheels & handrail. Welded rungs and a 10 year warranty. Large work surface and 225kg SWL for all maintenance requirements. 200mm solid rubber wheels allow for easy relocation on all terrains.

Code	Platform Height	Steps
WHDP02	565mm	2 Step
WHDP03	850mm	3 Step
WHDP04	1130mm	4 Step
WHDP05	1400mm	5 Step
WHDP06	1700mm	6 Step
WHDP07	1970mm	7 Step
WHDP08	2250mm	8 Step
WHDP09	2540mm	9 Step
WHDP10	2828mm	10 Step
WHDP11	3100mm	11 Step



Warthog Heavy Duty Cantilever Order Picker

Heavy Duty Cantilever Order Picker with wheels & handrail. Welded rungs and a 10 year warranty. Allows you to get right into and up against your work area without reaching out from the platform. Built tough, non-slip perforated deck and aluminium frame. 225kg weight limit.

Code	Platform Height	Steps
WHDPC02	565mm	2 Step
WHDPC03	850mm	3 Step
WHDPC04	1130mm	4 Step
WHDPC05	1400mm	5 Step
WHDPC06	1700mm	6 Step
WHDPC07	1970mm	7 Step
WHDPC08	2250mm	8 Step
WHDPC09	2540mm	9 Step
WHDPC10	2828mm	10 Step
WHDPC11	3100mm	11 Step



Fibreglass Platform Ladders

LADDERS & PLATFORMS

Bailey Fibreglass Job Station

Professional Fibreglass Job Station Platform Ladder suited for electrical work. Punchlock rungs, 170kg weight limit.



Branach Fibreglass

Industrial Fibreglass Platform Ladder with full surround handrail and adjustable terrain master feet. Suited for electrical & transmission work, 150kg weight limit.



Code	Height	Steps
FS13530	0.9M	3 step
FS13531	1.2M	4 step
FS13532	1.5M	5 step
FS13533	1.8M	6 step
FS13534	2.0M	7 step
FS13535	2.4M	8 step
FS13536	3.0M	10 step
FS13537	3.6M	12 step

Code	Height	Steps
FPW0.6	0.6M	2 step
FPW0.9	0.9M	3 step
FPW1.2	1.2M	4 step
FPW1.5	1.5M	5 step
FPW1.8	1.8M	6 step
FPW2.1	2.1M	7 step
FPW2.4	2.4M	8 step
FPW3.0	3.0M	10 step
FPW3.6	3.6M	12 step



Fibreglass Telescopic Platform Ladder

Easy Access AdjustaStep

Designed with the Electrical Trades in mind, this AdjustaStep Telescopic Platform ladder is non-conductive, and has a 150g load rating.

Height adjustable for working off a large safe platform at variable heights in seconds. Set front and back stiles to varying heights for working on steps or uneven ground. Handrail allows for 3 points of contact.

Can be fitted with accessories including tool bucket and full surround handrail.

Code
OXTPLF04-07

Platform Height
1.15 - 2.02M

Steps
4 - 7 step



Fibreglass All-In-One Telescopic Ladder

Easy Access Multi Purpose Ladder

Electrically safe non conductive fibreglass stiles. Easily seen hinge lock - its obvious when its engaged - locks automatically. Easily operated, simple pull out and release. Four settings for every application. 150kg rated.

Code
OXTLF04

Platform Height
1.2 - 4.5M

Steps
4 - 7 step



Fibreglass Double Sided



Easy Access Fibreglass Double Sided

Trade Fibreglass Double Sided Ladder suited for electrical work. Riveted rungs, 150kg weight limit.

Code	Height	Steps
OXDSF03	0.9M	3 step
OXDSF04	1.2M	4 step
OXDSF06	1.8M	6 step
OXDSF08	2.4M	8 step



Bailey Pro Fibreglass Double Sided

Industrial Fibreglass Double Sided Ladder suited for electrical work. Punchlock rungs, 150kg weight limit.



Code	Height	Steps
FS13977	0.9M	3 step
FS13978	1.2M	4 step
FS13980	1.8M	6 step
FS13981	2.1M	7 step
FS13982	2.4M	8 step
FS13983	3.0M	10 step
FS13984	3.59M	12 step

Fibreglass Dual Purpose

Bailey Pro Fibreglass Dual Purpose Ladder

Industrial Fibreglass Dual Purpose Ladder suited for electrical work. Punchlock rungs, 150kg weight limit.



Code	Height	Steps
FS13668	1.8 - 3.2m	6 step
FS13669	2.1 - 3.8M	7 step
FS13670	2.4 - 4.4M	8 step

Fibreglass Step Extension

Bailey Pro Fibreglass Step Extension Ladder

Industrial Fibreglass Step Extension Ladder suited for electrical work. Punchlock rungs, 150kg weight limit.



Code	Height	Steps
FS13985	1.8 - 3.2M	6 step+
FS13986	2.1 - 3.8M	7 step+
FS13987	2.4 - 4.1M	8 step +

Fibreglass Extension Ladders

Easy Access Fibreglass Extension Ladder

Trade Fibreglass Extension Ladder suited for electrical work. Side mounted rope which avoids tripping hazard. Triple pulley - three times easier to lift. Heavy duty feet. 'D' Shape steps for comfortable standing. Up to 150kg weight limit.

Code	Height	Steps
OXELF09	3.15 - 5.30M	9 step
OXELF11	3.75 - 6.50M	11 step
OXELF13	4.20 - 6.90M	13 step



Bailey Pro Fibreglass Extension Ladder

Industrial Fibreglass Extension Ladder suited for electrical work. Strong fibreglass construction resists sway, turn and flex. Fitted with pole support 'Vee' Bracket. Flat 'D' shaped rungs for secure footing. Side pulley and rope extension system keep rope away from the user's feet. Up to 150kg weight limit.

Code	Height	Step
FS13917	2.6 - 4.1M	8 step
FS13918	3.2 - 5.3M	10 step
FS13919	3.8 - 6.6M	12 step
FS13920	4.4 - 7.8M	14 step
FS13921	5.0 - 9.0M	16 step



Branach Extension Ladders

Fibreglass Extension Ladder - 160kg Rated

Our Branach PowerMaster Extension Ladder range features Branach's unique strongbox construction. This allows for dramatic rigidity which greatly reduces twist and sway. They are designed for maximum safety when working at heights. Branach care about safety and convenience. That's why they invented the Branach latch which is situated at the top of the ladder. With single hand operation and side-pull rope (no trip hazard) the latch protects the rungs. The Branach D Rung provides stability and comfort when working at height, and its non-slip-surface ensures safety in all weather. A proven product you can trust. The Swivel Foot gives workers peace of mind when working on rough and slippery surfaces. Branach's unique fibreglass patented box rail construction provides superior safety and meets the needs of industry leaders.

- Fibreglass stiles ensure workers are isolated from the ground, making the product suitable for electrical work
- Lightweight and effortless action to deploy
- Flat D rungs provide safety and comfort to the worker
- Strongbox construction results in dramatic reduction in twist and sway
- Branach Latch or Conventional Latch available
- All-weather resistant
- Swivel foot maximises grip on uneven ground
- Optional TerrainMaster feet for working on uneven ground
- Complies to AS/NZS 1892.3 Standard

Code	Height
FED4.0	2.7 - 4.0M
FED5.2	3.3 - 5.2M
FED6.4	3.9 - 6.4M
FED7.6	4.5 - 7.6M
FED8.8	5.1 - 8.8M
FED9.4	5.8 - 9.4M
FED9.8	5.8 - 9.8M

TerrainMaster Feet

The TerrainMaster removes the need for dangerous chocking or digging out the ground to level out the ladder. As the user and terrain are never consistent the TerrainMaster creates the safest environment to work in every time it is used.

- Manufactured from lightweight aircraft aluminium
- Eliminates lateral twist and sideways movement.
- Easy to store, spread, and level
- Base can be set to a width of 925mm to 1440mm.
- Leg height can be adjusted to up to 305 mm.
- Allows coping with a slope of up to 15 degrees.



Fibreglass Fall Control System Ladders

A system to ensure the height worker is safe while ascending, descending or accidental fall, slip or medical issue. The elements of the Branach Fall Control address:

STRENGTH required to arrest the user.

STABILITY required to remain upright during a fall event.

ANCHORING mechanism to ensure the user does not separate from the ladder structure.

RESCUE so the height worker can be safely lowered down by someone on the ground.

- The worker is safe from the moment they leave the ground.
- The stability system works from the ground up.
- Fall control system stems from the increased base of support.
- The ladder is secured with an integrated tether system.
- Integrated rescue by second user from the ground.
- Allows workers to work from the ladder with both hands comfortably and safely.
- To meet and exceed compliance and international standards.
- Design fit for purpose, critical piece of climbing equipment.
- Periodic inspection schedule recommended.
- Complies to AS/NZS 1892.3 Standard

Code	Height
FED4.0FC	2.7 - 4.0M
FED5.2FC	3.3 - 5.2M
FED6.4C	3.9 - 6.4M
FED7.6FC	4.5 - 7.6M
FED8.8FC	5.1 - 8.8M



Roof Ladders

Trade Roof Ladder

Access to any roof with a pitch of up to 45 degrees.
Ridge bracket and wheels can be brought separately.

Code	Size
CSL3.0	3.0M
CSL3.6	3.6M
CSL4.8	4.8M
CSL5.4	5.4M
ULRB	Ridge Bracket



Professional Roof Ladder

Safe access to any roof with a pitch of up to 45 degrees.
Easy and efficient solution for roof painting and maintenance.

Code	Size
CSRL3.0	3.0M
CSRL3.6	3.6M
CSRL4.8	4.8M
CSRL5.4	5.4M
CSRL6.0	6.0M



Industrial Roof Ladder

Compliant with NZS Portable Metal Ladder Standards. 150kg Industrial Load Rated.
Extensions to fit any roof by using Internal joiner plates with Tri-knob fasteners.
RH100 swivel plate head with angle-lock & 25mm foam rubber pad.

Code	Size
RL1.8	1.8M
RL2.1	2.1M
RL2.4	2.4M
RL2.7	2.7M
RL3.0	3.0M
RL3.3	3.3M
RL3.6	3.6M
RL3.9	3.9M
RL4.2	4.2M
RL4.5	4.5M
RL4.8	4.8M
RL5.1	5.1M
RL5.7	5.7M
RL6.3	6.3M
JP20	Joiner Plates (pair)
RH100	Head



Roll up...



Over ridge...



Turn...



Connect...



Climb Safely.

Roof Walkers

Light weight and compact for transporting. Ideal for iron roofs. Difficult roof access made easy. 800mm wide.

Code	Description
RCLR	Roof Walkers



Truck Stairs

Developed specifically for access to truck trays. No fixings required. Treads self level to suit tray heights of 1 - 1.5m. Industrial use.

Code	Steps
TF6T	6 step truck stairs



Self Levelling Stairs

Adjustable aluminium safety stair. Treads self level to suit the height. Safe, fast, easy access between floors, decks & in trenches. Folds flat for easy storage and relocation. Treads self level to suit any height. 300kg load rating.

Code	Steps
TF8	8 step safety stair
TF12	12 step safety stair
TF14	14 step safety stair



Painters Step Stool

Robust, stable and portable step stool for all trade work, painting, plastering, electrical etc. 150kg load rating. Non slip tread.

Code	Description
STS-360	Painters Step Stool



Super Trestles

One piece, height adjustable, sets up in seconds. Large work area for industrial, trade use. Non-slip perforated platform deck guaranteed and proven safety. Folds down flat for easy transport & storage. Simply select the height by sliding in the pin. Optional handrail available.

Code	Deck Size	Platform Height
WST1000	450 x 1200	400 - 1000
WST1300	450 x 1600	600 - 1300
WST1700	450 x 1600	700 - 1700
WSTFSH10	Optional Handrail suitable for WST1000	
WSTFSH17	Optional Handrail suitable for WST1300-1700	



Podium

Code MPP600

Easy to use, walk in/walk out access. Two height settings 0.9m, 1.1m. Full surround handrails. Folds up flat in one piece for compact storage in seconds. Perfect for ceiling work and low level access. Large non-slip aluminium one man platform. Requires 2 x stabilizers.



Ladder Parts & Accessories

Standoff Ladder Bracket

Code TSS-STANDOFF

- Spring-loaded locking latch makes it easier and quicker to install/remove than any other stabilizer on the market
- Installation requires no tools
- Mar-resistant rubber end caps protect work surface
- Span: 1.1 m, Standoff: 25 cm
- Paint can hook included
- For use on Singles and Extensions with 3.2 cm round-rungs, 3.8 cm flat rungs, 4.4 cm flat rungs and 4.1 cm flat rungs.



Bailey Walk Through Ladder Arms

Code RBMH

Fits to wall at rood edge to enable roof to be safely accessed with no fear of your ladder sliding sideways.



Permanent Ladder Bracket

Code RBMH

Fits to wall at rood edge to enable roof to be safely accessed with no fear of your ladder sliding sideways.



Roof Bracket

Code ROOF

Hooks over ridge on steep roofs to support the top of the ladder. Can be easily installed on most single ladders.



Ladder Stopper

Code LJLADSTO

The Ladder Stopper is of a tough All-Rubber construction – One size fits all Ladders. Works in the wet and is suitable for most surfaces like grass, wood, stone, concrete, tiles, etc.

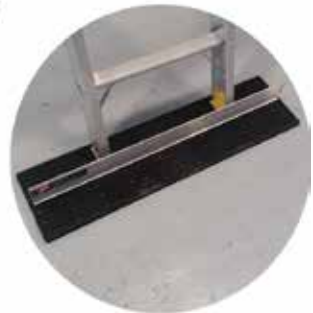

Steady On Bracket

Code MSTEADY

Designed to fit any size ladder and every type of spouting, you simply lift the bracket into place with a broom handle or roller pole, lean your ladder against it and up you go!



Ladder Parts

Parts for most makes and models

We offer a comprehensive range of ladder parts to cater to a wide range of makes and models. Our extensive inventory ensures that you'll find the perfect fit for your specific ladder needs to keep your ladder in top-notch condition.



Totalsite Ladder Parts

Code	Description
EIL-Y	Yellow oval inspection tag
LSH	LadderSafe Holder (also available in 10 pack)
LSI	Orange LadderSafe Insert (also available in 10 pack)
L120	Ladder Numbers 1 - 20 Industrial High-Stik
L150	Ladder Numbers 1 - 50 Industrial High-Stik





Ladder Inspection Service

Our ladder inspection service provides you a written report on the condition of your ladders including whether repairs are required and whether or not they can be done inhouse by yourselves.

Ladders that pass are given a test'n'tag label as shown below stating item number and next test date.

We use a modern software which allows our customers to manage and track their ladders (and other equipment) and view inspection history against this equipment. The software gives you access to detailed reports and can be accessed anywhere at anytime.



ITEM #:

NEXT INSPECT DATE:

MTH YEAR

INSPECTED BY:

This item should not be used if Next Inspection Date is overdue. This label must be recorded on a register so that if manufacturer labels are unreadable, Item # can be used to validate brand, type, standard and rating.

On Site • Up High • Safely

0508 88 5656





SCAFFOLDING

SCAFFOLDING



Equiptec Doorway Mobile Scaffold

Nifty little scaffold that doesn't need to be dismantled to fit through a doorway.

SCAFFOLDING



1.0mH x 2.0mL x 0.7mW
(no kickboards)
Code BCD1



2.0mH x 2.0mL x 0.7mW
(no kickboards)
Code BCD2



1.0mH x 2.0mL x 0.7mW
(with kickboards)
Code DOORWAY1



2.0mH x 2.0mL x 0.7mW
(with kickboards)
Code DOORWAY2

Equiptec Single Mobile Scaffold

Economy

Platform Height

2.0m
3.0m
3.9m
4.8m

2.0mL

SINGLE2-20T
SINGLE3-20T
SINGLE4-20T
SINGLE5-20T

2.5mL

SINGLE2-25T
SINGLE3-25T
SINGLE4-25T
SINGLE5-25T

3.0mL

SINGLE2-30T
SINGLE3-30T
SINGLE4-30T
SINGLE5-30T

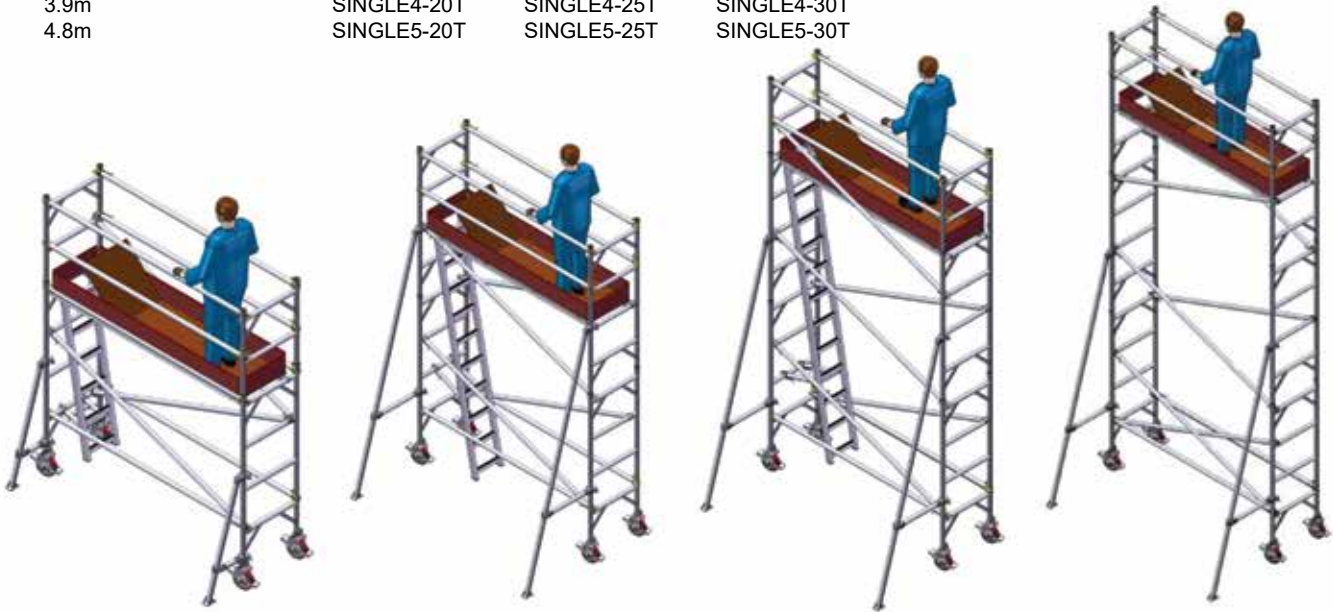

Equiptec Single Mobile Scaffold

With Extra Deck for Safe Assembly

Platform Height

3.0m
3.9m
4.8m

2.0mL

SS3-20T
SS4-20T
SS5-20T

2.5mL

SS3-25T
SS4-25T
SS5-25T

3.0mL

SS3-30T
SS4-30T
SS5-30T

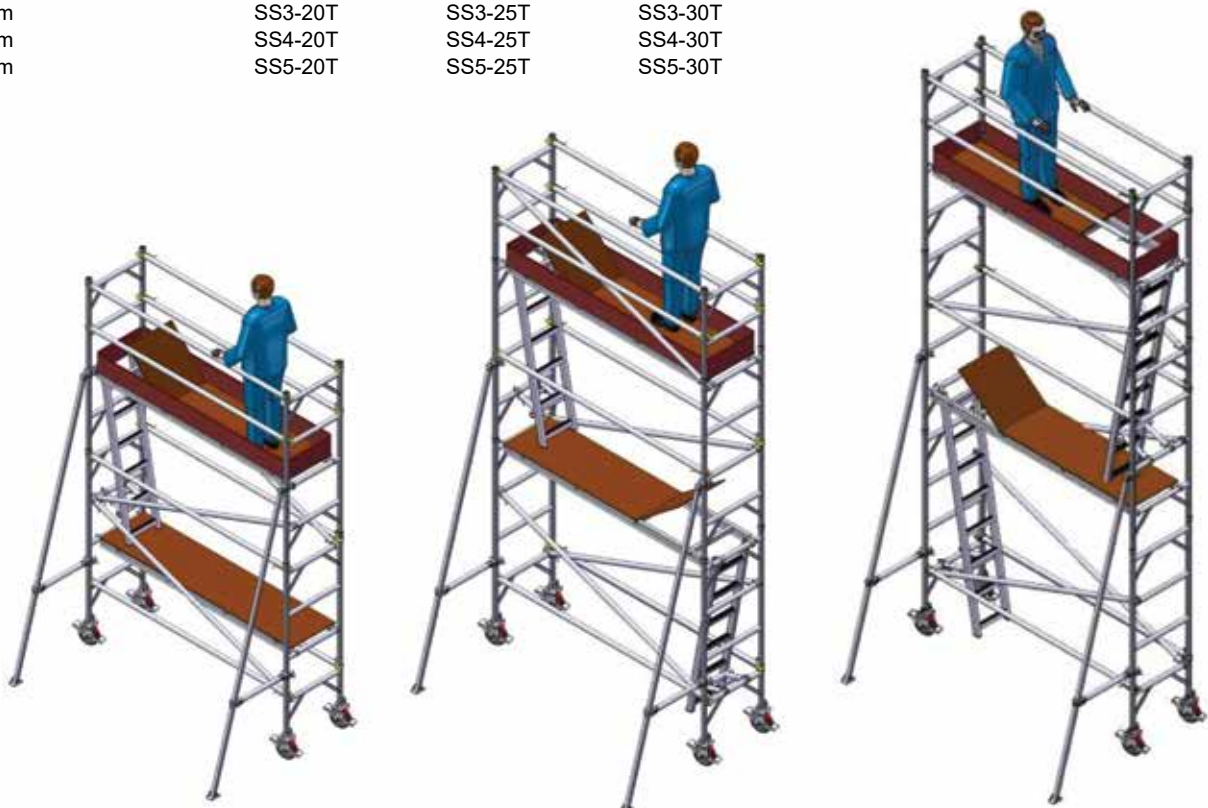

Equiptec Single Mobile Scaffold

Safe Assembly Full Spec

Platform Height

2.0m
3.0m
3.9m
4.8m

2.0mL

SSA2-20T
SSA3-20T
SSA4-20T
SSA5-20T

2.5mL

SSA2-25T
SSA3-25T
SSA4-25T
SSA5-25T

3.0mL

SSA2-30T
SSA3-30T
SSA4-30T
SSA5-30T

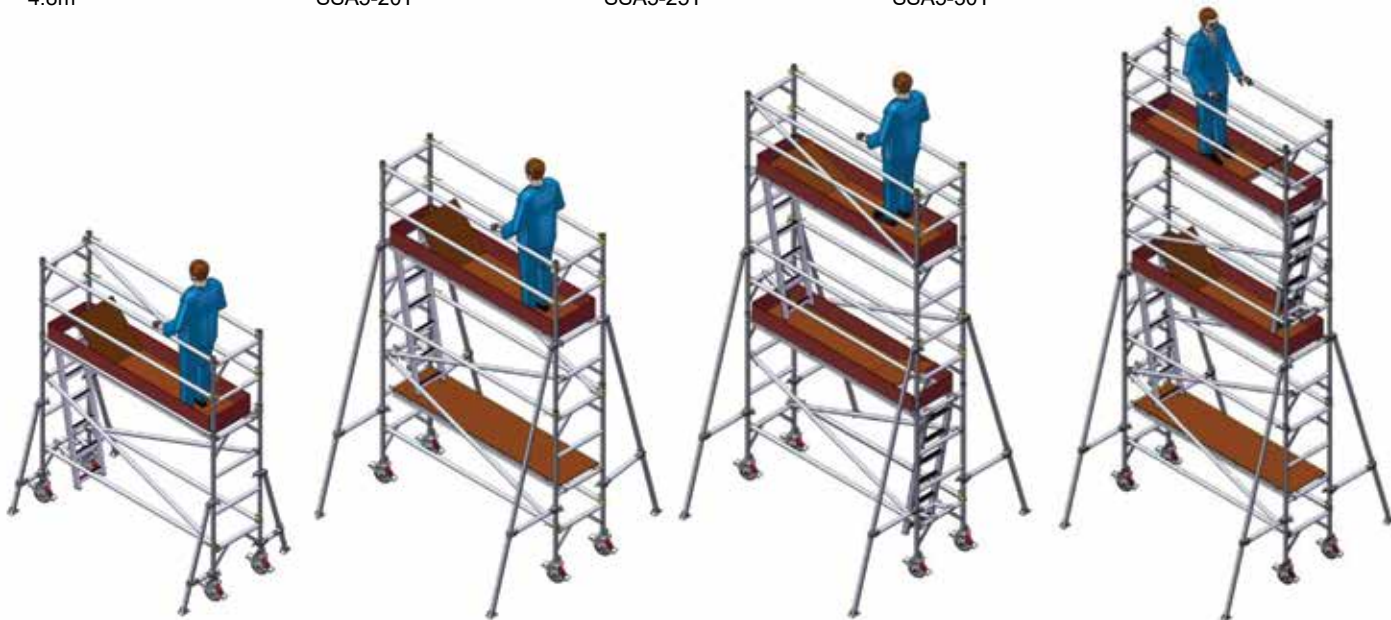

SCAFFOLDING

Equiptec Double Mobile Scaffold

Economy

Platform Height

2.0m
3.0m
3.9m
4.8m

2.0mL

DOUBLE2-20T
DOUBLE3-20T
DOUBLE4-20T
DOUBLE5-20T

2.5mL

DOUBLE2-25T
DOUBLE3-25T
DOUBLE4-25T
DOUBLE5-25T

3.0mL

DOUBLE2-30T
DOUBLE3-30T
DOUBLE4-30T
DOUBLE5-30T

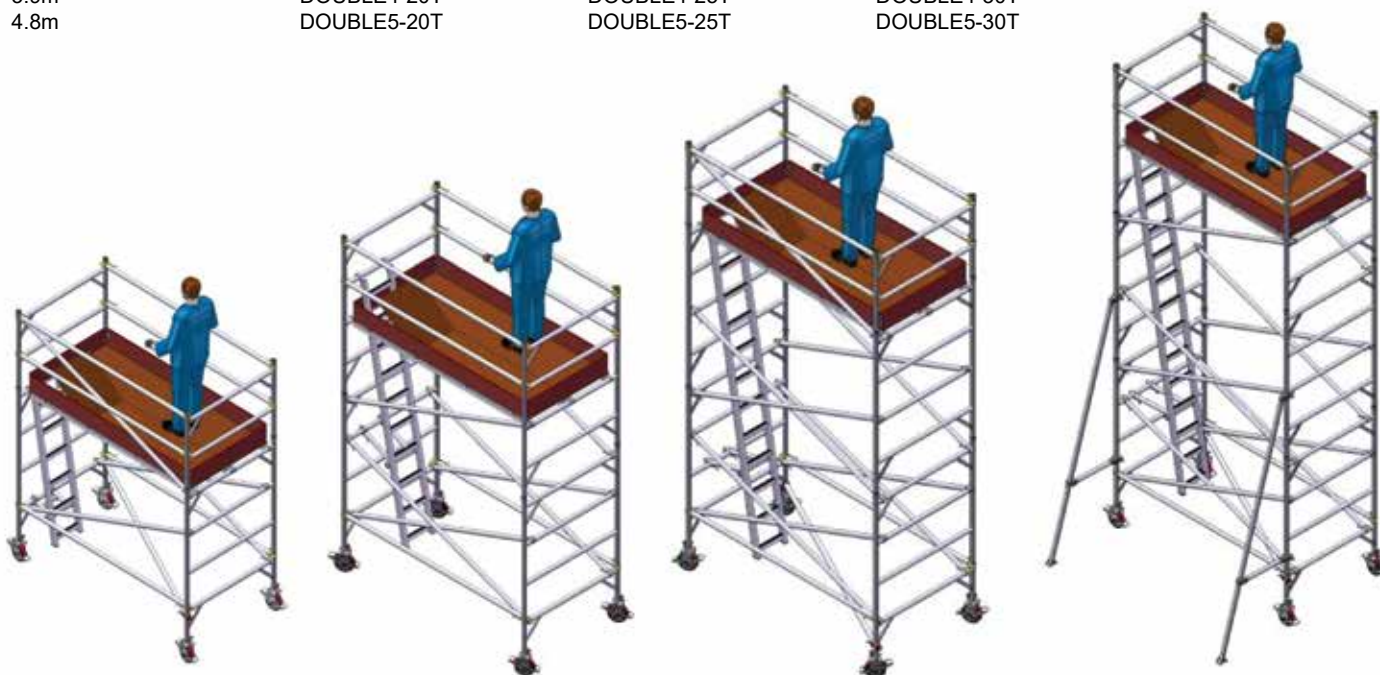

Equiptec Double Mobile Scaffold

With Extra Deck for Safe Assembly

Platform Height

3.0m	2.0mL
3.9m	DS3-20T
4.8m	DS4-20T
	DS5-20T

2.5mL

DS3-25T
DS4-25T
DS5-25T

3.0mL

DS3-30T
DS4-30T
DS5-30T



Equiptec Single Mobile Scaffold

Safe Assembly Full Spec

Platform Height

3.0m	2.0mL
3.9m	DDA3-20T
4.8m	DDA4-20T
	DDA5-20T

2.5mL

DDA3-25T
DDA4-25T
DDA5-25T

3.0mL

DDA3-30T
DDA4-30T
DDA5-30T



Equiptec Go-Gate

Many sites are insisting on handrails, midrails and toeboards on scaffolds at any height.

This makes accessing the scaffold difficult... well, it used to be before the Go-Gate was invented!



Why Equiptec Mobile Scaffold?

- Strongest** Almost impossible to break graspers and other parts
- Replaceable** In the unlikely event that a part does break, they're riveted in place, so can be easily replaced
- Sturdy** Feels a lot more rigid when it's used than other systems.
- Single System** You can purchase extra parts to increase your scaffold, and parts are interchangeable.
- Hireable** Available to hire should you require extra parts short term.
- Investment** Equiptec scaffold is a long term investment. Customers are still using it after 20 years.



Very sturdy platforms due to fully welded sub frame box section



Optional 'wind-keeper latch' prevents any chance of the wind lifting a platform



Virtually indestructible 'big-nosed' graspers



Sturdy kickboards prevents tools etc. from falling



Anti-jam spigots ensure frames fit together easily everytime



Large 200mm diameter casters, roll and brake easily

Easy Access Mobile Scaffold

Single Width

Platform Height

- 1.5m
- 2.0m
- 3.0m
- 4.0m

2.0mL x 0.7mW

- MOBI150S
- MOBI200S
- MOBI300S
- MOBI400S



Double Width

Platform Height

- 1.5m
- 2.0m
- 3.0m
- 4.0m

2.0mL x 1.3mW

- MOBI150
- MOBI200
- MOBI300
- MOBI400

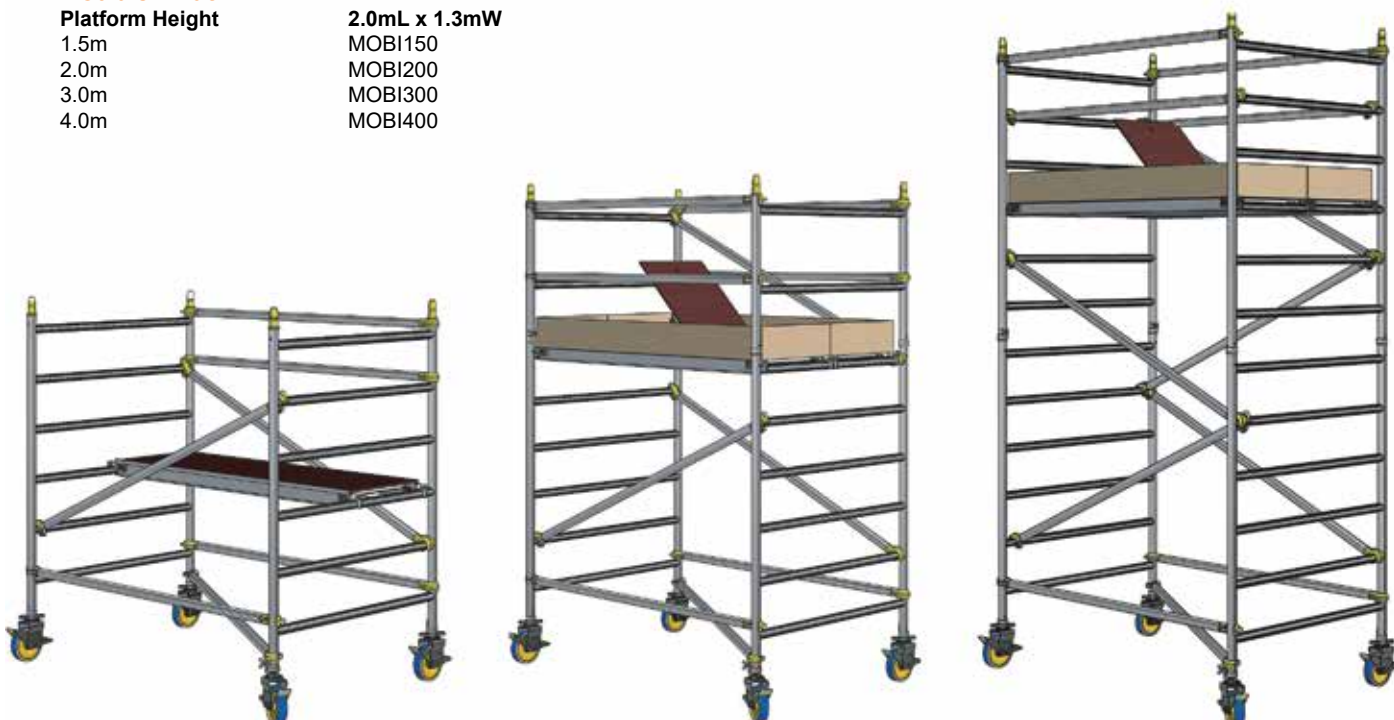

Fixed Scaffold

Scafpro Steel Scaffold is very quick to erect in many different configurations. Aluminium option also available.

Builders Pack 1
9.2m long
2.0m high platform

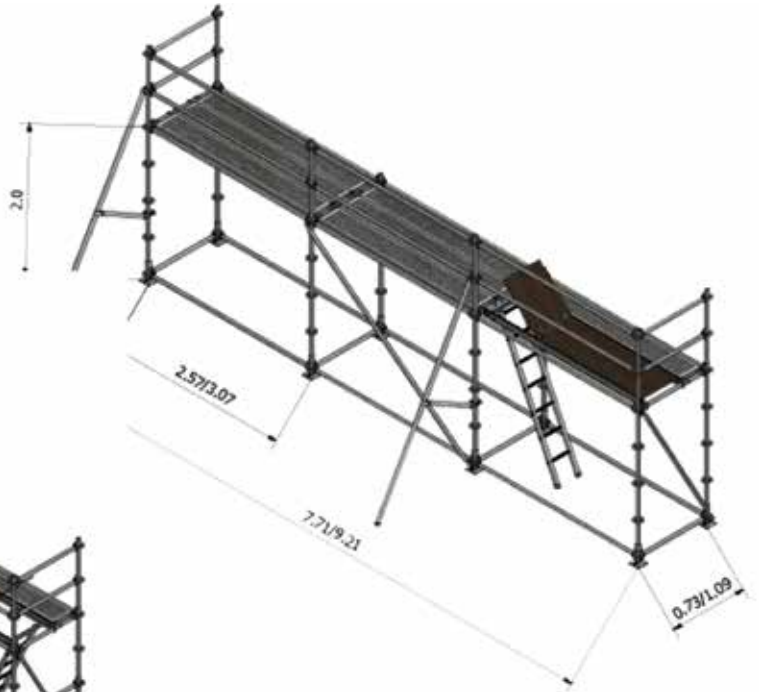
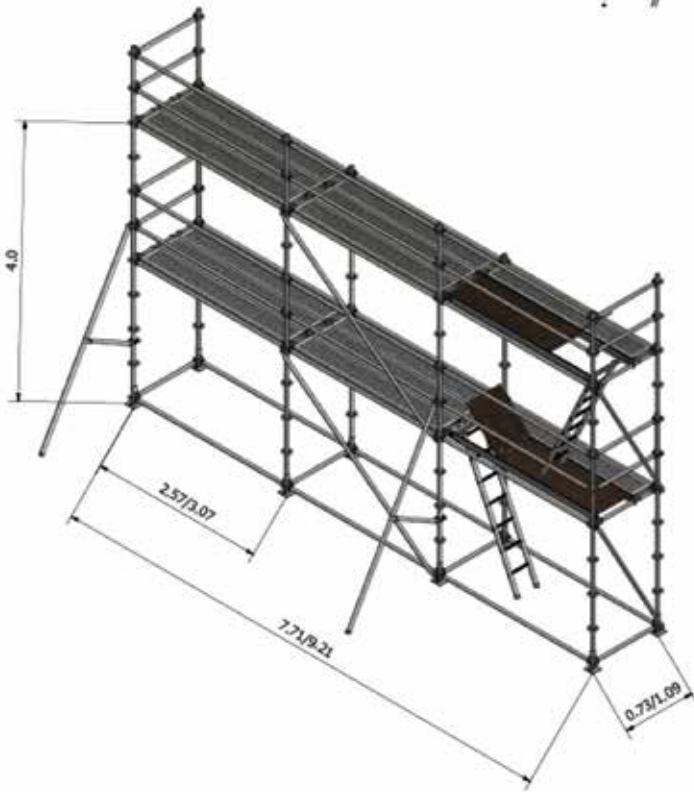

Builders Pack 2
9.2m long
2 bays high

Scaffold Safe Holder & Inserts

Scaffold Safe Yellow Holder
Code SCAFTYX

Scaffold Safe Insert
Code SCAFTS



Steel Scaffold Components



Swivel Coupler



Double Coupler



Single Coupler



Steel Full Frame



Steel Tube



Base Plate



Base Jack



Steel Half Frame



External Joiner



Internal Joiner



7/16 Spanner



Ratchet Spanner



Scaffold Belt



Level

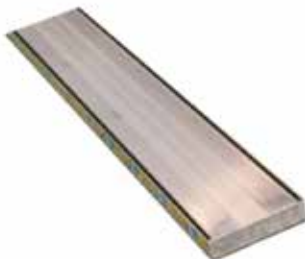

Aluminium Planks

Code	Length
ALP2.4	2.4m
ALP3	3.0m
ALP4	4.0m
ALP5	5.0m
ALP6	6.0m



Certified Scaffold Timber Planks

Code	Length
LSP30	3.0m



**Hire options
also available!
No job too big
or too small!**

EDGE PROTECTION

Garage & Sheds Bracket

Code EBG

- New housing
- Timber framed garages
- Pole framed sheds
- Steel framed sheds
- Stackable
- Timber or tube rails



New Build Soffit Mount Bracket

Code EBA

- New housing
- Stackable
- Gable ends
- Mono pitch roofs
- Timber or tube rails



Re-Roof System Bracket

Code EBR

- New housing
- Alterations
- Existing buildings
- Re Roofing
- Solar installation
- Roof painting/coating
- All roof types
- Stackable
- Timber or tube rails



Commercial Bracket

Code EBC

- DHS purlins
- Timber purlins
- Timber and concrete floor perimeters
- Parapet walls
- Stackable
- Timber or tube rails
- Extendable/adjustable with multi bracket



Standard Edge Protection

These aluminum Edge Protection Packs are quick to install and can accommodate to different height requirements. The packs are designed to be used without fixing to the building or using any patching, making it the ideal solution for roofers, plumbers and restorers.

Code PACKE
52m Full House Edge Protection

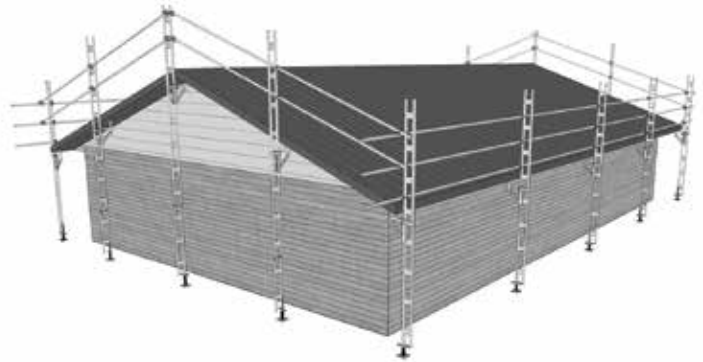

Code PACKA
12m Edge Protection including 1/2 Gable End

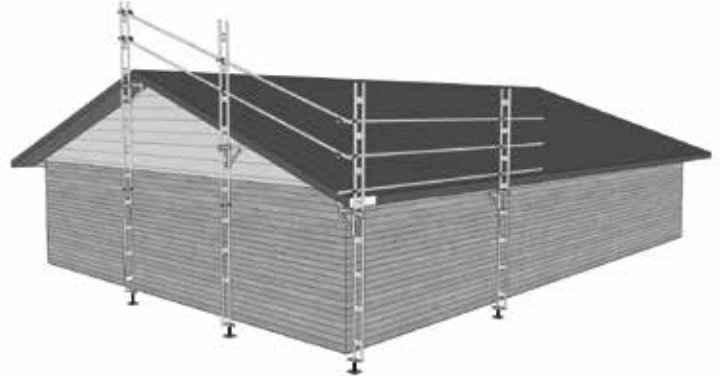

Code PACKC
6m Straight Edge Protection

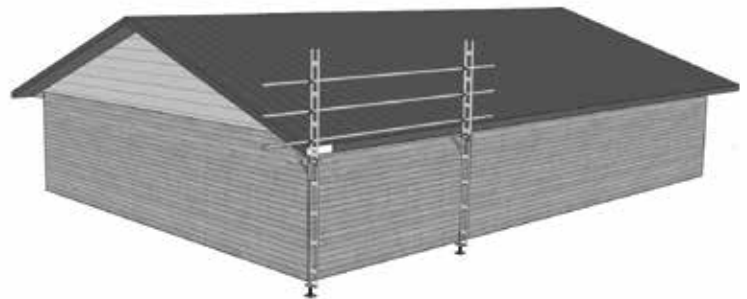

Quik-Guard Edge Protection

Quik Guard keeps staff safe, is fully compliant, effective and efficient. Quik Guard roof edge protection is installed fast, provides a strong safe protective barrier and can be dismantled quickly when the job is complete.

Quik Guard has no need to penetrate the building structure, building roofs and walls are left untouched. Quik Guard does not require rakers (when used at 5.0m or below)! This system can be installed fast, even on difficult sites. Tested and certified compliant with safety standard AS/NZS4994.1.

Code	Size
REP12	12 lineal meters
REP36	36 lineal meters
REP68	68 lineal meters
REP104	104 lineal meters
REP200	200 lineal meters

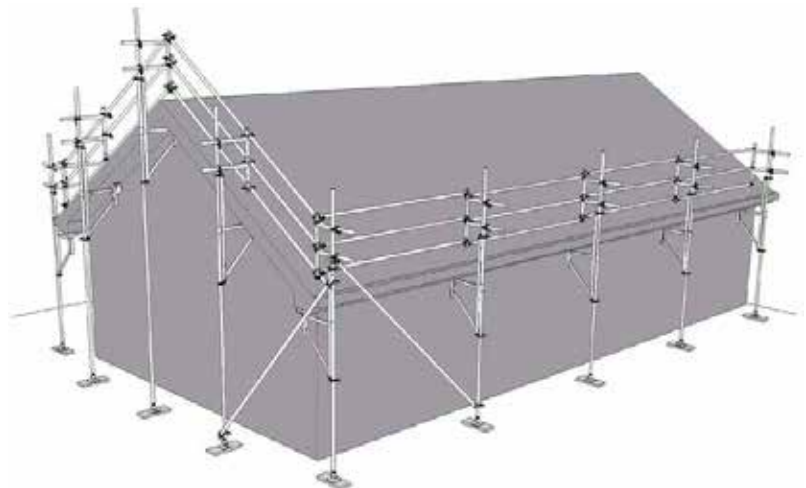

Platform Edge Protection

The free-standing Platform EdgePro system is very lightweight and reduces the downtime of waiting for your scaffold company to arrive. EdgePro and can simply be erected on uneven ground and with a little training, you can do it yourself.

Code PACKK

0.5m – 3m high platform. 70L/m including internal and external corners.

PACK SIZES
CUSTOM
DESIGNED
TO SUIT YOUR
NEEDS

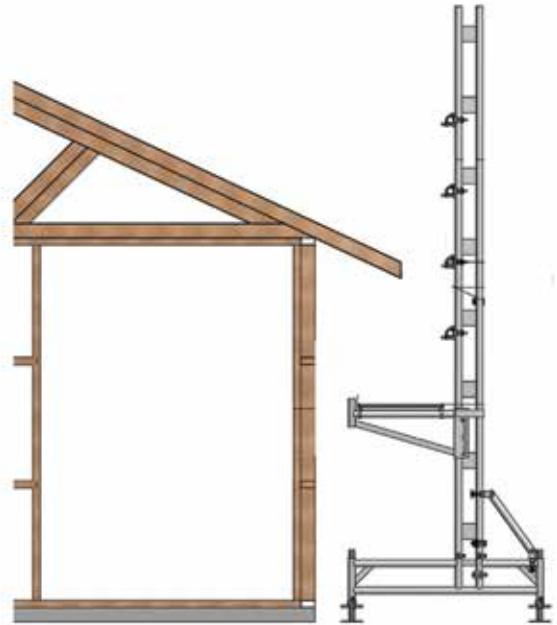
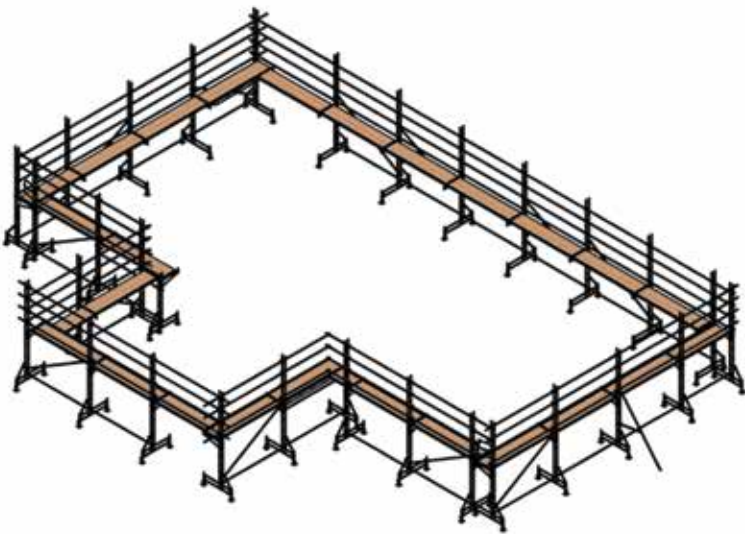

Code PACKJ

0.5 – 3m high platform. 21m straight

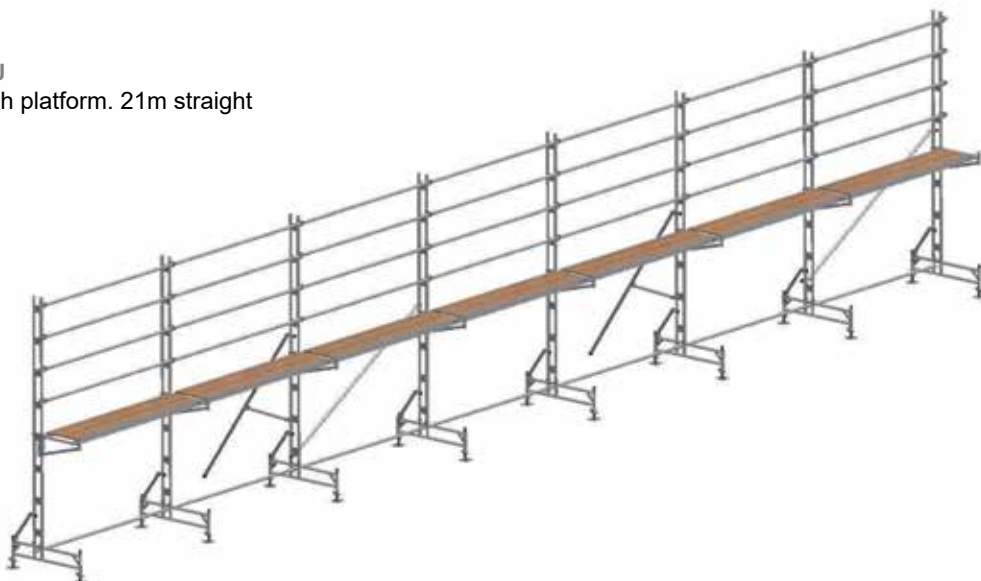

King Klamps

Code: KKM1000

King Klamps can be fitted both vertically and horizontally to provide a secure edge protection system on concrete, parapets, mezzanine floors and many other applications.



Parapet & Slab Clamp

Code: EPB

- Parapet walls
- Concrete slab edges
- Floor mounting with toeboard
- Commercial buildings
- Timber or tube rails
- Stairwells and voids
- Lightweight tube rails





HEIGHT SAFETY

HEIGHT SAFETY

Harnesses

Zero Utility Fall Arrest Harness

Code HUS0017 (Z-30)

Simple and effective fall arrest harness for total safety compliance. Certified to AS/NZS 1891.1:2007.



Zero Superior Multi-Purpose Harness with Positioning Belt

Code HSP0167 (Z+52)

Ideal for the professional construction worker that demands comfort and premium safety. Breathable mesh fabric in the shoulder and leg pads gives the wearer support and comfort while helping to keep them cool and dry. Certified to AS/NZS 1891.1:2007.



Zero UtilityS Fall Arrest Harness

Code HUSB017 (Z-30S)

Suitable for general tradesmen, construction workers, roofing, vertical climbing and access equipment. Basic buckles for economy. Simple and effective fall arrest harness for total safety compliance. Certified to AS/NZS 1891.1:2007.



Zero Elite Construction Harnessfall Arrest & Suspension Harness

Code HEP4678 (Z-61)

Rescue attachment points on the shoulders, ideal for confined space raising and lowering. Versatile design allows use for a multitude of work applications. Certified to AS/NZS 1891.1:2007.



Zero IsoElec Isolated Electrical Linesman Harness

Code HIP4678 (Z+81/EISOL)

The IsoElec harness provides all the comfort and benefits of Elite Construction Harness but includes specially isolated metal parts to protect electrical linesman and tower workers from electrical arc. The IsoElec Harness is also suitable for general purpose, light abseil, work positioning and fall arrest. Certified to AS/NZS 1891.1:2007.



Zero Plus Riggers Harness

Code HPP1679 (Z+87R)

Comfortable and efficient construction harness; Suitable for general purpose construction work, roofing, confined space, vertical climbing and access equipment.



Zero Works Abseil / Rescue Harness

Code HWP4689 (Z+71)

A favourite with emergency services and rope access technicians, the Works Rescues Harness provides additional flexibility with its V construction. Versatile design allows use for a multitude of applications including general rope access, abseil, rescue, industrial fall arrest, work positioning, tower and confined space.



Premium Y-Tech Pro Tower Harness

Code YTECH-PRO

The Y-Tech Pro Tower Harness has been developed following extensive consultation with our power utility end-users, giving them the features they desire most. This harness has been designed to eliminate restriction on the shoulders, allowing total upper body movement.



Height Safety Kits



Zero Basic Roofers Kit

Code RKB-200
Basic Z-30S Harness and 15m Ropeline

Zero Roofers Kit

Code SKB101 (ZB-101)
Suits general roof work. Quick Connect Harness, 15m Ropeline, Anchor, Sling & Backpack.



Zero Tradesman Kit

Code SKB501 (ZB+501)
The complete kit for tradesmen working at height. Z+32 Harness with double lanyard, 15m Ropeline, & Apex Multi Helmet.

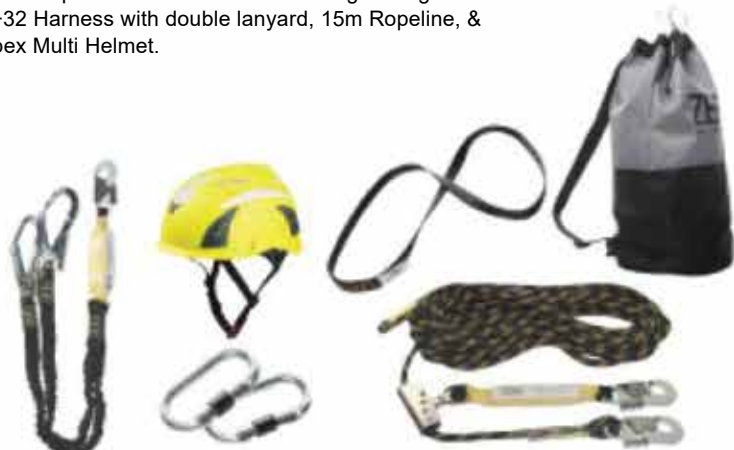

Helmets



Apex Flash Helmet

Code APX-02

Quality construction ensures the Exo industrial helmet is built to last and has provision for all the standard accessory types that are needed on the job. Impact and penetration protection meets and exceeds AS/NZS 1801.



Apex Multi Helmet

Code APX-05

Designed to mountaineering impact certification, for industrial use, with a collation of the best design features for an industrial quality helmet for work at height and general site safety.

Will your helmet protect you from multiple side hits if you fell?

“When fall arrest systems are used, an appropriate helmet shall be worn to protect the worker from head injury during an uncontrolled fall”

- Quote Best Practice guidelines for working at height in NZ.



Petzl Vertex Vent Helmet

Code A10V

A very comfortable and stylish height safety helmet with six point mesh liner which conforms to the shape of the head for improved comfort. Ventilation holes with sliding shutters. Optional head lamp, visor and earmuffs. EN12492.



Pinnacle Vent Helmet

Code ZPE-01

European manufactured and certified to meet even the most stringent demands of the industrial market, the ZERO® Pinnacle EXO series are bolstered by the standard for mountaineers (EN 12492:2012) for superior protection whether on the ground or working at height.



Pinnacle Volt Helmet

Code ZPE-02

European manufactured and certified to meet even the most stringent demands of the industrial market, the ZERO® Pinnacle VIKO series meet the standard for industrial protection (EN 397).

Helmet Accessories



Zero Pinnacle Visor - Full Face

Code ZPVF01

A medium impact rated ultra-clear full-face visor designed to fit directly to all Pinnacle Volt helmets. With no metal parts, the Low Elec visor provides protection against short circuit electric arc.



Zero Pinnacle Visor - Half Face

Code ZPV01

The impact-resistant ZERO Clear visor fits directly to the full range of Pinnacle helmets and protects from flying particles.



Pro Choice Safety Gear Python® Slimline Hard Hat Earmuffs

Code HHEMPYTS

Class 5, SLC80, 31dB. Hearing protection for noise levels to 116dB(A). Fits a wide range of hard hats



LED Sensor Head Lamp

Code HL120

Can be fitted to most helmets. 100 Lumen LED.

Lanyards



Zero 2m Single Webbing Lanyard with Snaphooks

Code LWZ00W3 (ABM-T3)

Webbing lanyard with snaphooks at both ends. Includes shock absorber. 2m length.



2m Single Adjustable Rope Lanyard with Scaff and Snaphook

Code LLZ0RX5 (ABM-RL5)

Single Adjustable rope lanyard with snaphook and scaffhook. Includes shock absorber. Adjustable length from 1.2m to 2m.



Zero Double Elasticated Lanyard with Snaphook & Scaffold Hook

Code LSZ2W5E (ABM-2T5E)

Elasticated webbing lanyard with 2 scaffhooks. ideal for scaffolders as lanyard straps don't dangle around the legs.



Zero Adjustable Lanyard

Code LTZ0WX3 (ABM-TX3) / Code LTZ0WX5 (ABM-TX5)

2m Adjustable webbing lanyard with snaphooks. Suitable for EWP use where the lanyard must be shortened. ABM-TX5 comes with Scaffold hooks

Zero Logix Retractable Webbing Lanyard

Code LLRZ0W3 (AH-210)
 Fall arrester with webbing retractor.
 Max length 2.25m EN360,
 AS/NZS1891.3



2m Webbing Double Retractable Lanyard

Code CR-02X2
 Ideal for scaffolders who are required to be attached at all times.



Adjustable Rope Pole Strap with Aluminium Rope Grab and Swivel Hook

Code SBL12AS
 The combination of AS/NZS approved Kernmantle rope and rope grab allows the user to quickly adjust the length of the strap on the fly.



Adjustable Pole Strap

Code WPR0WX3 (ZF-725)
 AS/NZS1891.2. 2.5m ideal for lineworkers



Work Positioning Lanyard with Rope Grab 3m

Code WPG0RX3/030 (AF-130/030)
 Work positioning device with rope grip shortener for perfect length



Zero Linostop 15mm Ropeline with Adjuster

Codes:
 RV20RX3/150 (ZRL-15)
 RV20RX3/200 (ZRL-20)
 RV20RX3/300 (ZRL-30)
 15m rope line with a rope adjuster and shock absorber. Other lengths available - 20m & 30m. Certified to AS/NZS 1891.3:1997.



Zero 11mm Tactix Kernmantle Static Rope, 30m

Code ZTE11/30 (ZT-11/30)
 Tactix kernmantle static rope complete with sewn loop ends with reinforced eyelets and one snaphook. 11mm rope, 30m Long.

Anchors



Zero Roof Anchor To Go

Code AAP000M (AZ-200)
 Quick anchor for iron roofs



Zero Tether Plate 500mm

Code ATD000M (AZ-160)
 Diversionsary anchor (must be used in conjunction with a primary anchor) to provide a safe secure anchorage point for metal roofing tasks, both fall arrest and restraint.



Templink Flexible Anchor

Code TPKL

Flexible anchor can fit to almost any iron roof and many other situations.



Froglink Anchor

Code FROGLINK

Permanent energy absorbing anchor for fitting to metal roof sheeting. Quick and effective permanent anchor with fall impact absorption.



Temporary Lifeline

Adjustable static line for 1-3 people. Ideal for roof work.

Code

AZP0WX3/200
109501

20m 3 Person (Zero)
30m 2 Person (Camp)



Zero Alu Beam Anchor

Code AAB00XM (AT-250)

EN795, CLASSB. Designed as temporary, portable anchor point. It is to be fixed onto horizontal steel beam which must be mounted permanently to the stable structure. Quick connect mechanism fitted in seconds



Webbing Sling

Webbing sling available in six different lengths. 22kN

Code

ASP000W/006 (ZS-60)
ASP000W/008 (ZS-80)
ASP000W/012 (ZS-120)
ASP000W/015 (ZS-150)
ASP000W/020 (ZS-200)

Length

60cm
80cm
120cm
150cm
200cm



Quicklink Oval Karabiner

Code PJ-507

Excellent for semi-permanent fixings. Screw lock. 72mm x 17mm with 17mm opening. Steel/zinc plated



Zero Triple Lock D Karabiner

Code PJ-500

Triple Lock, D Shape Karabiner. High tensile steel, yellow chromate finish.



Zero Screw Gate Oval Karabiner

Code PJ-501

Screw gate oval karabiner. High tensile steel, zinc plated. 165gms



Zero Rope Fall Arrester with Karabiner

Code FFORM1 (AC-040)

Guided type fall arrester for flexible anchorage line. Can be attached at any point along the 11-12mm rope.



Zero Kevlar Webbing Retractable Lanyard

Code FKR00W3 (WR-100/06)

Retractable fall arrester allows for extra movement. EN360:2002



Trauma Straps - pair

Code ZC-2062

Helps prevent the effects of suspension trauma by prolonging the allowable suspension time for a person who has experienced a fall.

Confined Space



Zero Aluminium Tripod 229cm with Chain

Code TD00AX (TM-9)

This industrial multi-functional Tripod is ideal for lifting loads, assisting in access to confined spaces, as well as for securing and rescuing people. 500kg rated.



Zero Winch with Pulley & Mounted Bracket 20m

Code WD00CM/200 (RUP-502-20)

Lifting rescue device. Lifting and lowering device with automatic braking. Ideal for confined space work and rescue.



Spreader Bar with Karabiners

Code CS00W1 (ZSB)

Spreader Bar suitable for use with RUP-502 winch & Z-40 harness for all confined space access.



Zero Retractable Rescue Winch/Inertia Reel - 25m

Code FBR2RC3/250
(CRW-300/25)
A combination of a self locking device and rescue lifting device; a type 3 fall arrester. Suitable for use on TM9 Tripod. EN360, EN1496, Class B



Skylotec Milan 2.0 Hub

Code A-028
Rescue system to recover a suspended person from almost any situation - both ascending and descending. Includes bag and karabiners.

Rescue Kit 50m

Code AR-010
Zero Rescue Descent Kit is an evacuation and rescue unit designed to rescue/recover a person at height. Descending only. It can be used during rescue operations at height for works who are suspended in PPE.



Controlled Rate Descender

Code RED000R (YIE-003)
For self evacuation from bucket trucks and pole top rescue. Excludes rope



A range of Kit Bags available
Various Styles & Sizes.

ELEVATED WORK PLATFORMS

Man Cage

Code FMC 19-120

The 2 person man cage is designed for forklift use to safely carry out tasks of short duration and occasional usage such as maintenance work or stock-take.

- Safe working load 250kg
- Unit weight 110kg
- Galvanised zinc coated



Slipper Locking Pins



Anchor Points



Handy Tool Tray

4m - 5m Slab Scissor Lifts

The Snorkel S3010P is an innovative push-around mini scissor lift, which provide a cost-effective way to safely work at low level heights indoors.

Designed to withstand the demands of construction sites and the rental industry, the Snorkel S3010P is a heavy-duty and robust mini scissor lift, which is easy to use and simple to maintain. The S3010P can lift 240kg to a working height of 5.0m.

Features

- Auto brake system
- Tilt sensor
- Saloon-door style entry gates
- Integrated battery charger 90V – 240V
- Battery charge indicator
- Forklift pockets
- Emergency lowering system
- Non-marking casters
- Slide-out service trays
- 2 year parts & labour, 5 year structural warranty

Code	S3006P	S3008P	S3010P
Max. working height	4.0m	4.5m	5.0m
Max. platform height	2.0m	2.5m	3.0m
Platform size (outside)	1.1m x 0.52m	1.1m x 0.52m	1.1m x 0.52m
Overall width	0.75m	0.75m	0.75m
Overall length	1.2m	1.2m	1.2m
Stowed height	1.7m	1.8m	1.8m



Quick Up 12 Lift

Features

- Adapted to each project
- Its lightweight makes it suitable for the most fragile grounds
- Its compactness enables to go through doors and elevators
- Its stabilizers with rubber protect the floor surface
- Easy to use
- Quick set up by 1 person
- Transportable on a trailer or a van
- 4 wheels for easy manual maneuvering
- Best value for money
- Minimal maintenance

Code QUICKUP12

Working height	12.3 m
Platform height	10.3 m
Platform size	0.68 x 0.66 m
Length	1.4 m
Width	0.8 m
Width - stabilised	2.06 m
Length - stabilised	2.26 m
Weight	415 kg



EcoLift

Ideal for finish work, multi-story projects. Used by mechanical, electrical and HVAC contractors, painters, etc.

Features

- Facility Maintenance: Cleaning, painting, decorating and general building maintenance in offices, schools, hospitals, institutional and industrial maintenance
- Intuitive to operate – turn handle to elevate Patented* lift mechanism, no power required

Code	Ecolift 50	Ecolift 70
Working height	3.33m	4.03m
Platform height	1.5m	2.2m
Machine Weight	180.08kg	304.81kg
Platform Length	0.71m	0.85m
Platform Width	0.6m	0.65m





6m - 10m Slab Scissor Lifts

The Canadian built Skyjack machine is designed for the hire industry so is very robust. Maintenance and servicing work is seldom required, and is very simple to do.

Features:

- Crossover symmetrical 4WD
- Independent/auto leveling outriggers
- 0.9m roll out platform
- Electric engine
- 90° swing out engine tray
- Tilt alarm with drive & lift cut-out
- Overload sensing system
- Pothole protection system
- Solid rubber, non marking tyres

Code	SJIII3215	SJIII3219	SJIII3220	SJIII3226	SJIII4626	SJIII4632
Working height	6.57m	7.79m	8.10m	9.92m	9.92m	11.75m
Platform height	4.57m	5.79m	6.10m	7.92m	7.92m	9.754m
Machine Weight	1120kg	1579kg	1889kg	1890kg	2935kg	2935kg
Platform Length	1.63m	1.63m	2.13m	2.13m	2.13m	2.13m
Platform Width	0.66m	0.66m	0.71m	0.71m	1.07m	1.07m



8m - 10m Rough Terrain Scissor Lifts

Exclusive cross over symmetrical 4WD system for superior traction. Featuring up to 50% gradeability, these machines can meet the needs of the most challenging job site terrain. Standard features also include an easy to use 1.52m roll out extension deck, which can be secured in multiple positions for increased platform space and improved reach capabilities. Driveable at full height with the roll out deck fully extended.

Features:

- Crossover symmetrical 4WD
- Independent/auto leveling outriggers
- 1.52m roll out platform
- Diesel/electric engine
- 90° swing out engine tray
- Tilt alarm with drive & lift cut-out
- Overload sensing system
- Pothole protection system
- Solid rubber, non marking tyres

Code	6832RTE	6826RT	6832RT
Working height	11.75m	9.92m	11.75m
Platform height	9.8m	7.9m	9.8m
Machine Weight	4026kg	3305kg	3655kg
Platform Length	2.44m	2.44m	2.44m
Platform Width	1.42m	1.42m	1.42m
Electric or Diesel	Electric	Diesel	Diesel



LIGHTING SOLUTIONS

LIGHTING SOLUTIONS

Moma Solar

Temporary Solar Pop Up Lighting

Portable solar lighting solutions for all applications. Our lights are used on mine sites, construction sites, and for road maintenance, off grid or temporary road Lighting, Car Park Lighting Pathways, Event Lighting. Totally stand alone and adaptable to all stand alone solar lighting requirements.

The Original solar pop up street lighting series is available from 20W to 100W and fully charged last up to 7 days.

LIGHT WEIGHT

- 30kg when empty
- 2 man lift
- No lifting equipment required
- 600KG When filled with water

EFFICIENT TRANSPORT

- Fits onto a pallet
- Units are stackable

EASY MAINTENANCE

- Water recovery system
- Fast fill water inputs
- 25 years plus life expectancy

SIMPLE DESIGN AND OPERATION

- Tamper resistant bungs
- Difficult to climb
- Ideal for low skilled labour utilisation





Swivelpole™ Incorporating Maxis™

Access Made Easy

Swivelpole™ 45° lowering pole solutions provide safe, simple and affordable access to light fixtures and equipment.

The innovative access solution eliminates the risk of working at heights, through the controlled lowering of light fixtures and equipment to a safe working height and ergonomic service position.

Cast steel joint with minimal moving parts. Suitable for hazardous locations and harsh environments. The only solution that allows conversion of existing poles to lowering poles.



SAFETY

Light fixture is inverted and lowered to a safe working height and ergonomic service position.

SIMPLICITY

Easy to install and operate. Allowing easy upgrade to LED technology.

SAVINGS

Maximised profit through substantially reduced operating and maintenance costs.

FLEXIBILITY

Multiple product configurations to suit Greenfield and Brownfield applications.



PROPPING & SHORING



We deliver the full propping package!

OUR PROP RANGE

Code	Description	Length	Weight
STANDARD VERTICAL PROPS			
H1037	Standard Prop No. 00	0.7m to 1.1m	12.7kg
H1040	Standard Prop No. 0	1.0m to 1.7m	13.5kg
H1041	Standard Prop No. 1	1.6m to 2.8m	18kg
H1042	Standard Prop No. 2	1.9m to 3.3m	21kg
H1043	Standard Prop No. 3	2.5m to 3.9m	23.5kg
H1044	Standard Prop No. 4	3.2m to 4.8m	27kg
TILT PANEL PROPS			
H1049	Tilt Panel Prop No. 0	1.1m to 1.8m	20.5kg
H1050	Tilt Panel Prop No. 1	1.7m to 2.9m	25kg
H1051	Tilt Panel Prop No. 2	2.0m to 3.4m	28kg
H1052	Tilt Panel Prop No. 3	2.6m to 4.0m	30.5kg
H1053	Tilt Panel Prop No. 4	3.3m to 4.9m	34kg
SHISHAM ADJUSTABLE PROPS - LARGE			
H1054	Adjustable Prop - Mini Trench	1.0m to 1.7m	20kg
H1076	Adjustable Prop - Supa Trench	1.5m to 2.5m	26kg
H1055	Adjustable Prop - Mini	2.4m to 4.1m	36kg
H1047	Adjustable Prop - Mini 2	3.1m to 4.8m	41kg
H1056	Adjustable Prop - Supa Mini	3.1m to 4.5m	47kg
H1057	Adjustable Prop - Standard	4.4m to 7.0m	61kg
H1058	Adjustable Prop - Special	5.7m to 9.4m	70kg
H1059	Adjustable Prop - Jumbo	6.4m to 11.5m	106kg
H1060	Adjustable Prop - Supa Jumbo	8.5m to 14.5m	137kg
SHISHAM ADJUSTABLE PROPS - HEAVY DUTY			
H1062	Adjustable Prop - Hercules 3	6.8m to 11.5m	200kg
SOLDIERS			
H4040-003	Superslim Soldier	1.2m	29.6kg
H4040-002	Superslim Soldier	1.5m	34.6g
H4040-027	Superslim Soldier	2.7m	58.8kg
H4040-001	Superslim Soldier	3.6m	76.5kg
CHIPPY STICKS			
H1220	CS20 Lightweight Prop	2.3m	9.6kg
H1225	CS25 Lightweight Prop	2.8m	12.2kg
H1229	CS29 Lightweight Prop	3.2m	14.4kg



HIRE & SALES OPTIONS



Shisham Adjustable Props

For almost 40 years, these props have been developed, improved and manufactured to meet every challenge faced in the concrete precast and tilt up industry in Australia and New Zealand. The design is square instead of round, because kilo for kilo, square is safer than round.

They're also better for handling and stackable. Every prop is individually certified and manufactured to the current rigorous AS3850-2015 standard. Multiple height adjustment options up to 14.5M.

Heavy duty swivel foot with detailed adjustment. Lifetime warranty. Galvanised. All genuine parts available. Great weight to kn ratio.

When a knee brace is fitted to the Jumbo and Supa Jumbo Props the kN increases. A fully extended, the Jumbo Prop will be 20kN and the Supa Jumbo becomes 12kN.



PROPPING



Shisham Hercules 3 High Load Prop

Advances in Tilt Slab construction techniques have brought new challenges as panel sizes increase and the resulting loads escalated. Enter Hercules! A new range of push pull props from Shisham to suit the new frontier in high load applications. No more wasted labour bolting soldiers together! With Hercules 3 you have a more versatile and cost efficient way of erecting panels than ever before.

- 6.8m 100kN closed position
- 9.0m 75kN middle position
- 11.5m 35kN full extended position
- Test no. HT3
- 260kg



Galvanised Tilt Props

TSS Galvanised Props & Tilt Props

The traditional heavy duty builders prop ranging in size from 1.0m through to 4.8m extended, used traditionally in vertical and horizontal shoring and propping, Total Sites galvanised prop can also be modified to be used as a lightweight panel prop by fitting 2 swivel feet and another locking nut. Parts available.

Brand	Code	Name	Closed	Open	Weight
Totalsite	PROP00	No.00 TSS Prop	0.69m 44kN	1.1m 24kN	12.7kg
Totalsite	PROP0	No. 0 TSS Prop	1.0m 134kN	1.7m 47kN	13.5kg
Totalsite	PROP1	No. 1 TSS Prop	1.6m 86kN	2.8m 42kN	18.0kg
Totalsite	PROP2	No. 2 TSS Prop	1.9m 92kN	3.3m 26kN	21.0kg
Totalsite	PROP3	No. 3 TSS Prop	2.5m 40kN	3.9m 8.5kN	23.5kg
Totalsite	PROP4	No. 4 TSS Prop	3.2m 33kN	4.8m 5.6kN	27.0kg
Totalsite	TPF	Tilt Foot			
Totalsite	DSSA-099	Prop Nut			
Totalsite	85H1025	Bolt & Nut			



Shoring Towers

ST100 Towers

The ST100 tower has been designed for maximum flexibility and speed of assembly. The towers are light and easy to assemble. No tools required. The stacking frames are offset, it can only be erected in the right order. Diagonal braces clip in, no tools required.

Engineering

One of the strongest towers available with a single leg load up to 53kN and 214kN per tower. Max tower height of 22.29m.

Features

Able to be built on the ground and lifted into position for large commercial and civil construction. Type Tested System, no need for static calculations. Refer to engineering height chart. Easy assemble means on-site labour can erect without need for contractors. Towers excellent for edge form support, scaffold platform can be built off the tower.

Components

Only 3 frame components and 5 total mean no confusion on site. Frames come in 500mm increments. A square base frame makes levelling the tower quick and easy. Square base frame also allows easy set out of large projects. Steel I beam or Timber GT24 bearer available. TSS steel decks securely fasten to the frame to aid in safe assembly. Lockable frames for crane transport. Rossett design means scaffold can be used in conjunction with towers.



PROPPING



DUO Formwork

The DUO system formwork is characterized by its low weight and extremely simple handling. Not only the material used is very innovative, but also the entire concept: with a minimal number of different system components, walls, columns and slabs can be easily and efficiently formed with only a minimal number of different system components. DUO is the optimal solution for small-sized components with lower surface requirements as well as for restoration work where no crane can be used.

Besides the panels including the formlining, most DUO accessories are made of the new innovative composite material with a polymer basis. This material is extremely light and, at the same time, has a high load-bearing capacity.

Universally applicable

High utilization rate of the components through flexible forming of walls, columns and slabs using only one system.

Fast and easy to assemble

Fast working procedures thanks to simple formwork rules and uncomplicated application without the use of a hammer.

Installation without the use of a crane

High productivity and crane-independence due to the low weight

- Heaviest components just 24.9kg
- Half the components of other systems
- Engineering and design service available
- Proprietary system, simply twist and lock together
- All related concrete machinery and tools available for hire
- All formwork and concrete consumables in stock



Lightweight Props

The Total Site 'Chippy Stick' is a lightweight prop specifically designed for temporary support in lightweight walls and formwork in the building and construction industry.

Made from Duragal Steel, these props are corrosion resistant, trustworthy and easy to use. The swivel feet and height adjustment make them easy to position and fix into place.

Code	Closed	Full Extended	Mass kg
CS25	2.53m 10kN	2.8m 8kN	14.5kg
CS29	2.93m 10kN	3.2m 8kN	16.0kg
CS36	3.63m 10kN	3.9m 8kN	19.5kg



Accessories

The Complete Package

After you receive your designs, we supply the props, shims, anchors, drill bits and burke bars to finish the install.

Shims

Shisham packers or shims are quality made and proven to withstand NZ construction standards. For many applications including tilt panel levelling.

Brand	Code	Description
Shisham	SHISSHIM1BAG	1mm Brown 100x150mm Bag of 250
Shisham	SHISSHIM2BAG	2mm Blue 100x150mm Bag of 200
Shisham	SHISSHIM3BAG	3mm Green 100x150mm Bag of 150
Shisham	SHISSHIM5BAG	5mm Yellow 100x150mm Bag of 100
Shisham	SHISSHIM10BAG	10mm Black 100x150mm Bag of 40
Shisham	SHISSHIM15BAG	15mm Grey 100x150mm Bag of 40
Shisham	SHISSHIM20BAG	20mm White 100x150mm Bag of 30



Prop Anchor Bolts

Code	MPA	Max Tensile Load kN	Max Shear Load kN	Torque Nm	Bolt	Bolt Length	Drill Hole Diameter
SBA20120	22	15.77	26.82	150	M14	120mm	20mm
MKT18107*	25-30	18.8	37.7	80	M12	107mm	18mm
MKT18117*	25-30	18.8	37.7	80	M12	117mm	18mm
MKT18127*	25-30	18.8	37.7	80	M12	127mm	18mm
MKT24130*	25-30	26.3	52.7	160	M16	130mm	24mm
MKT24150*	25-30	26.3	52.7	160	M16	150mm	24mm

* Seismic Rated C1+C2

Washers

20X50X50X6 M20 50mm x 50mm x 6mm H/Duty Square Washer - Galv
 24X50X50X6 M24 50mm x 50mm x 6mm H/Duty Square Washer - Galv



SBA20120

MKT24150

MKT24130

MKT18127

MKT18117

MKT18107

Shisham Burke Bar

Code TSSBURKEBAR

To aid in placing concrete panels.



Temporary Precast Support Bracket

Code TPSB

Angle brackets designed for panel to panel connections.



Prop Adjusting Spanner

Code SHISSPANNER

For easy adjustment of props.



Drill Bits

Code	Description
SDSPX12016	DART 12.0 x 160mm SDS+ Cross Tip Hammer Drill Bit
SDSPX12021	DART 12.0 x 210mm SDS+ Cross Tip Hammer Drill Bit
SDSPX12026	DART 12.0 x 260mm SDS+ Cross Tip Hammer Drill Bit
SDSPX12030	DART 12.0 x 300mm SDS+ Cross Tip Hammer Drill Bit
SDSPX12045	DART 12.0 x 450mm SDS+ Cross Tip Hammer Drill Bit
SDSPX14026	DART 14.0 x 260mm SDS+ Cross Tip Hammer Drill Bit
SDSPX16026	DART 16.0 x 260mm SDS+ Cross Tip Hammer Drill Bit
SDSPX18026	DART 18.0 x 260mm SDS+ Cross Tip Hammer Drill Bit
SDSPX20026	DART 20.0 x 260mm SDS+ Cross Tip Hammer Drill Bit
SDSPX22026	DART 22.0 x 260mm SDS+ Cross Tip Hammer Drill Bit
SDSPX24026	DART 24.0 x 260mm SDS+ Cross Tip Hammer Drill Bit

*Other sizes available





FENCING

Temporary Fencing

2.1m High Perimeter Fence Panels

Code FENCE2.2/2

Quality temporary fence panels.

2.1m high x 2.2m wide
60mm x 155mm x 4mm mesh
2mm thick tube

4mm thick mesh
Flat stackable panels

Don't be deceived by lightweight look-a-likes!

Pedestrian Gate

Code: FENPEDISGATE

**PEDESTRIAN
GATE
AVAILABLE**



1m High Fluro Pedestrian Fence Panels

Code FENHV

Quality pedestrian panel that complies with new regulations for pedestrian fencing in high impact fluro orange.

1000mm h x 2100mm L

Vertical bars 100mm spaces



Fencing Accessories



Heavy Duty Steel Feet

Code FENFT

Heavy duty steel foot for fence panel

750 x 150mm

9kg



Hinge Clamp

Code HINCP

Hinge clamp



Fence Clamp

Code FENCP

Panel brace for temporary fencing



Skid Foot

Code FENSD

Skid foot for vehicle gate



Panel Brace

Code FENBRA

Panel brace for temporary fencing

INDEX

TOOLS

Abrasive Files.....	31
Bolt Cutters & Benders.....	22
Bricklayers Supplies.....	74
Brooms & Brushware.....	24-25
Builders Lines.....	26
Bull Floats & Accessories.....	11-13
Chisels & Bolsters.....	26
Concrete Brooms.....	17
Concrete Rakes & Spreaders.....	16-17
Concrete Scrapers.....	19
Concrete Screeds.....	11
Concrete Testing Equipment.....	20
Concrete Texture Roller Sleeves.....	18
Concrete Tool Handles.....	15
Crow Bars.....	23
End Cutting Pliers.....	22
Extension Cords.....	28
Fasteners & Ratchets.....	32
Gumboots.....	26
Hacksaws.....	28
Hammers.....	29
Knee Pads & Boards.....	19
Knives.....	28
Marking Equipment.....	30
Measuring Products.....	31
Measuring Wheel.....	29
Power Box.....	28
Rubbing Stones.....	19
Rules.....	31
Shovels.....	21
Spray Bottles.....	31
Tape Measures.....	31
T-Bar.....	16
Tie Wire Puller.....	26
Trowels	
Brick Trowels.....	9
Coving Trowels.....	7
Edgers.....	8
Finishing Trowels.....	4-5
Floats.....	9
Fresno Trowels.....	14
Gauging Trowels.....	10
Groovers.....	7
Magnesium Trowels.....	6
Margin Trowel.....	10
Pointed Trowels.....	6
Pointing Trowels.....	10
Pool Trowels.....	6
Walking Trowels.....	14
Window Trowels.....	10
Work Lights.....	27

EQUIPMENT

Angle Grinders.....	51-52
Concrete Mixers.....	57
Concrete Vibrators.....	40-42
Core Drill Accessories.....	64
Core Drills.....	61-63
Cut Off Saw.....	56
Demolition Breakers.....	53-54
Demolition Hammers.....	53-54
Diesel Heaters.....	66-67
Floor Saw.....	50
Grinder Cup Wheels.....	80
Grout Pumps.....	47
Laser Levels.....	65
MSB Adjustable Forms.....	48
Plate Compactors.....	44-45
Pole Tamper.....	46
Power Cutters.....	55
Power Generators.....	58-59
Power Screeds.....	43
Power Trowel	
Finishing Blades.....	39
Ride On.....	37
Walk Behind.....	34-36

Rebar Shaker.....	44
Rotary Hammers.....	54
Sprayers.....	73
Tamping Rammers.....	46
Tuff-Form Plastic Boxing.....	49
Vacuum - Slurry.....	70
Vacuums - Dust Extractors.....	68-69
Waterblasters.....	60
Wheelbarrows.....	71-72

DIAMOND CUTTING & DRILLING

Blades	
Asphalt.....	76
Chasing.....	79
Concrete.....	76
General Purpose.....	76
Panel Cutter.....	79
Tile.....	88
Tuck Pointing.....	79
Wide.....	79
Diamond Hand Pad.....	83
Drill Bits - Core.....	86-87
Drill Bits - Masonry.....	84-85
Grinding Cups.....	80-82
Masonry Abrasive Cup.....	83
Plastic Disc for Masonry.....	83
Polishing Pads.....	83

OXIDES

Permacolour Colourmix.....	89-90
----------------------------	-------

CONCRETE CONSUMABLES

Chemicals	
Acetone.....	96
Acid Etching.....	95
Concrete Additives.....	94
Curing & Anti-Evaporation.....	93
Mineral Turpentine.....	96
Moss & Mould Kill.....	96
Mould Preparations.....	94
Release Agents.....	92
Remedial Products.....	93
Sealers & Waterproofers.....	95
Surface Retarders.....	92
Masking Tapes & Films.....	100-101
Paint Brush.....	102
Paint Roller Frame.....	102
Paint Roller Kit.....	102
Paint Rollers.....	102
Protective Wear (PPE).....	103-105
Sealants.....	103-105

LADDERS & PLATFORMS

Aluminium	
Dual Purpose.....	109
Double Sided.....	111
Extension.....	112
Order Pickers.....	112-113
Platform.....	108-109
Single.....	110
Telescopic.....	110, 115
Fibreglass	
Double Sided.....	115
Dual Purpose.....	116
Extension.....	116-117
Platform.....	114-115
Step Extension.....	116
Ladder Parts & Accessories.....	121-123
Podiums.....	121
Roof Ladders.....	119
Roof Walkers.....	120

Self Levelling Stairs.....	120
Super Trestles.....	121
Truck Stairs.....	120
Painters Step Stool.....	120

SCAFFOLDING

Equiptec	
Doorway.....	126
Double Width.....	128-129
Single Width.....	127-128
Go Gate.....	130
Easy Access	
Double Width.....	131
Single Width.....	131
Fixed Scaffold.....	132
Scaffold Components & Acc.....	133

EDGE PROTECTION

Edge Protection Brackets.....	136-137
Edge Protection Packages.....	138-139
King Klamps.....	140
Parapet & Slab Clamps.....	140
Platform Edge Protection.....	139

HEIGHT SAFETY

Anchors.....	147-148
Confined Space.....	149
Controlled Descenders.....	150
Harnesses.....	142-144
Height Safety Kits.....	144
Helmets.....	145
Helmet Accessories.....	146
Karabiners.....	148
Kit Bags.....	150
Lanyards.....	146-147
Rescue.....	150
Ropeline.....	147
Webbing Slings.....	148

ELEVATED WORK PLATFORMS

EcoLift.....	153
Man Cage.....	152
Quick Lifts.....	153
Rough Terrain Scissor Lift.....	154
Slab Scissor Lifts.....	154

LIGHTING SOLUTIONS

Moma Solar Lighting.....	156
Swivelpole.....	158

PROPPING

Accessories	
Anchor Bolts.....	166
Burke Bar.....	167
Drill Bits.....	167
Precast Support Bracket.....	167
Prop Adjusting Tool.....	167
Shims.....	166
Duo Formwork.....	164
High Load Props.....	161
Lightweight Props.....	165
Shisham Adjustable Props.....	161
Shoring Towers.....	163
Standard & Tilt Props.....	162

FENCING

2.1m High Fence Barriers.....	170
1.0m High Fence Barriers.....	171
Fencing Accessories.....	171